



Installation and User Manual

**Model: IK35 (1151)**



KITCHEN/LAUNDRY SINKS



BATHROOM BASINS



TAPWARE



RANGEHOODS



COOKTOPS



WASTE DISPOSALS

**INTRODUCTION OF DEVICE**

**Rocker switch product**



**Touch control product**



- 1) Front panel
- 2) Comand panel
- 3) Aluminum Cassette Oil Filter
- 4) Illumination

**Picture 1**

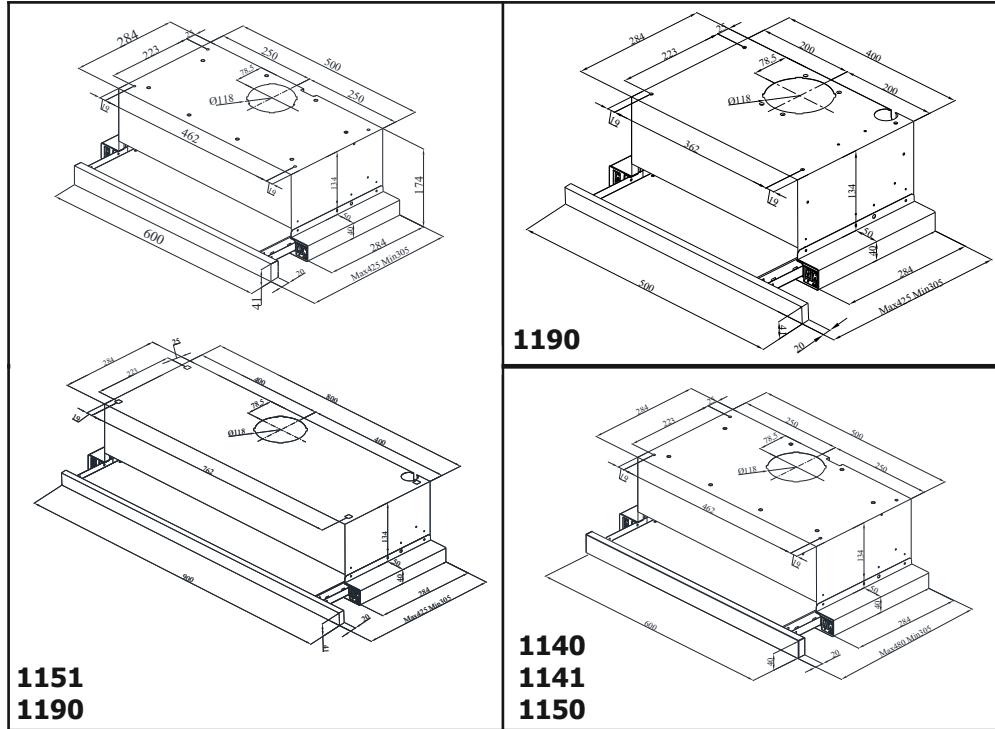

**Figure 1**

## REMOTE CONTROL

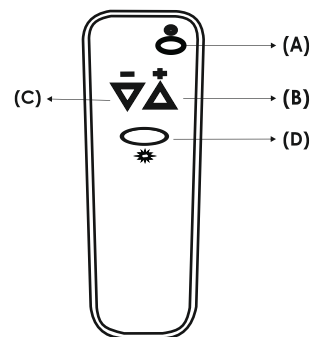

- A) Motor on/off
- B) Speed up
- C) Speed down
- D) Switch lamps on/off

## WARNINGS AND SAFETY PRECAUTIONS

\*This product is designed for usage at home.

\*Your products usage voltage is 220-240 Volts~50Hz

\*Grounded plug is used at your product's electric network cable. This cable should definitely be plugged in a grounded socket.

\*All electrical networks should be set by a qualified electrician.

\*Installation applied by unauthorized people may cause the product to operate at low performance, damage of the product and accidents.

\*Power supply cable should not be exposed to press or smash during montage. Network cordon should not be placed near the cookers; it may cause fire if it melts.

\*Do not plug into the socket before installation of the product is completed.

\*Keep the plug at a reachable place so that you can unplug it in case of any danger.

\*Do not touch the lamps when they are on for long time. Lamps may hurt your hand as they will be hot.

\*Kitchen cooker hoods are designed for usage during normal and home-style cooking. If it is used for other purposes, failure risk occurs and it will be out of warranty.

\*Follow applicable rules and directions for passing out outlet air. (This warning is not valid for usage without chimney.)

\*Flaming foods should not be cooked under the product.

\*Start your product after you put pot, fry-pan etc. on the hob. Otherwise high temperature may cause some parts of your product to get deformed.

\*Before you take pot, fry-pan etc. from the hob, put their lids on.

\*Do not leave hot oil on the hob. Pots that have hot oil in them may cause selfignition.

\*Pay attention to curtains and covers during cooking of meals like frying because oil may flare up.

\*Make sure that filters are changed in convenience. Filters that are not changed at appropriate time has risk of causing fire due to oil that will be gathered on them.

\*Do not use filter materials that are not flame resistant instead of filter.

\*Do not operate your product without aluminum filter; do not remove filters when the product is on.

\*In case of flame, cut power of the product and the cooking appliances. (Cut power of the product by plugging it off the socket).

\*Your product may cause fire risk if cleaning is not applied periodically.

\*Cut power of the product before maintenance process. (Cut power of the device by unplugging it)

\*When chimney hood and the appliances working with energy other than electricity are operated at the same time, negative pressure in the room should not be more than 4 Pa ( $4 \times 10^{-5}$  bar)

\*If there is an appliance working with fuel or gaseous fuel at the same place with your hood, this appliance's exhaust should be isolated from its volume totally and the appliance should be hermetic type.

\*When chimney connection is applied to your product, use ducts of 150mm or 120mm diameter. Duct connection should be as short as possible and should include few bends.

\*Keep package materials away from children as they may be dangerous for them.

\*Be sure that your child does not play with the product. Do not allow kids to use your product.

\*If power supply cable is damaged, this cable should be changed by its producer or its service agency or a personnel who is a specialist at the same level in order to prevent a dangerous situation.

**“CAUTION: Accessible parts may become hot when used with cooking appliances”**

**"The appliance is not to be used by children or persons with reduced physical, sensory or mental capabilities, or lack of experience and knowledge, unless they have been given supervision or instruction"**

**Warning about Transportation and Carriage**

\*All the materials used at package of your product are suitable for recycling.

\*Please comply with the signs on the product's box during transportation.

\*Hold the holders placed at sides of the box in order to carry your product.

**If you need transportation;**

\*Keep the original box.

\*Carry your product in its original box; comply with the carrying signs on the product's box.

**If there is no original package;**

\*Do not put heavy material on the chimney hood.

\*Keep the external surface from bash.

\*Pack your product to avoid damages.

**Installation, taking off your product from its package:**

\*Check if there is any deformation on your product.

\*Transportation damages and failures should immediately be reported to the transportation responsible.

\*If you notice any damage please report to the seller.

**\*Do not allow children to play with packing material!!!**

\*In case of flame, cut power of the cooker hood and the cooking appliances, cover the flame. Never use water in order to extinguish it.

**Use “MAX 6 A” fuse at cooker hood installment for your security.**

**In order to use the cooker hood efficiently:**

\*Pay attention to aluminum filters' cleaning periods and changing periods of carbon filters.

\*Use the product at middle speed if high suction power is not necessary.

\* In order to ensure that ventilation occurs correctly, windows of the kitchen should be kept closed.

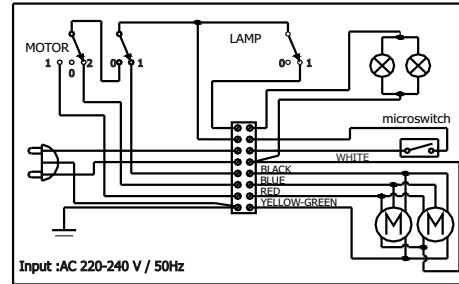

**1140-1150-1151  
(3 SPD)**

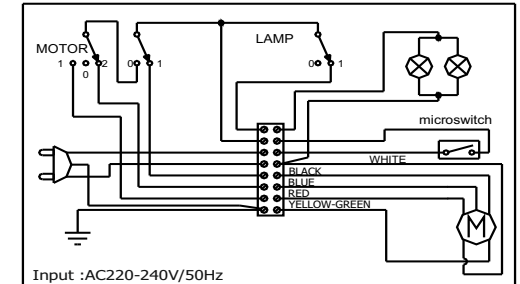

**1190 (3 SPD)**

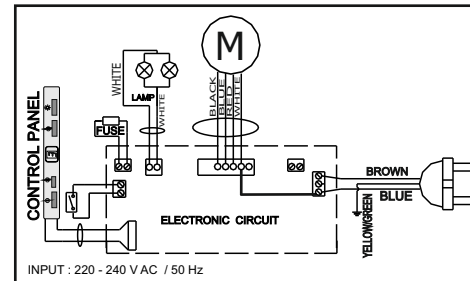

**1141**

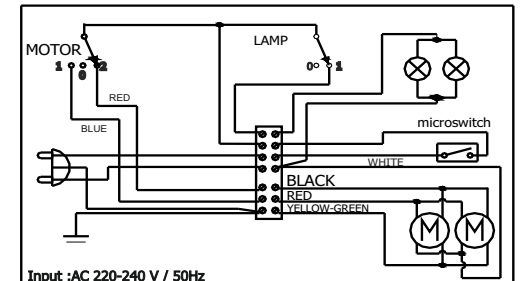

**1151  
(2 SPD)**

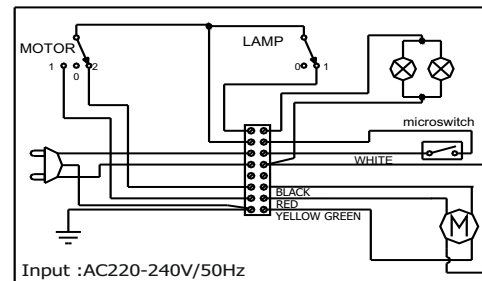





**1190  
(2 SPD)**

## The Usage of Touch Screen Control Panel

### Usage of 3 Speed Digital Control

#### Usage

Remove protective folio on the inox product after installation.



**Speed Selection** The product has 3 speeds of ventilation level. One of 1,2,3 speeds is selected in accordance with steam of cooking or fry. Motor is started pressing  control button on the front panel. Speed is increased pressing  button, and decreased by pressing  button. Automatic timer (TIMER) is available at the models with electronic remote control. When you press  button more than 2 seconds, timer function will be on for 15 minutes. When the timer is on, Display will signal and the motor will be off automatically 15 minutes later. Please use the cooker and the product at the same time to enable circulation. Doing so, air suction power will be affected positively. We recommend you to operate your product for few minutes more after the cooking is completed to enable absorption rest of smell and steam.



#### Illumination

The product has 2 lamps and one lamp button to operate illumination. Press lamp button in order to start illumination.

#### Cleaning Periods of the Aluminum Filters:

Filters should be cleaned when C signal appears on Display or (according to usage) each 2-3 weeks. In order to remove C signal, after the filters are cleaned and replaced to their place, press  button more than 3 seconds (when the product is at off position). Letter "E" will appear on Display and the product will operate as normal. If you would like to continue using the product without deleting C signal, when you press the  button active speed will appear for 1 second, then C signal will appear once more and the motor will continue operating.

**NOTE: C signal will appear after usage of the product for 60 hours.**

## Standard Accessories

### Plastic Outlet (Picture 2)

Plastic outlet mounted to air outlet of the cooker hood

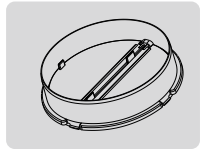

Picture 2

### Place of the Product:

After installation of your product, distance between range hood and electrical hob should be at least 65 cm and gas hobs at least 75cm. **Figure 2**

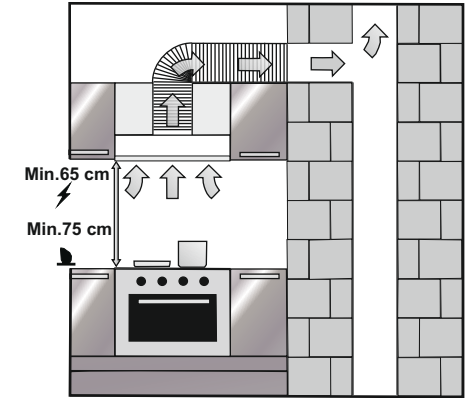

Figure 2

### Installation, taking off your product from its package:

\*Check if there is any deformation on your product.

\*Transportation damages and failures should immediately be reported to the transportation responsible.

\*If you notice any damage please report to the seller.

**\*Do not allow children to play with packing material!!!**

### ASSEMBLY UNDER CLOSET

4 Holes are bored on the wooden plate under the closet by using assembly pattern.

A chimney outlet hole larger 130 mm is bored on this wooden plate by using assembly pattern.

### INSATLLATION TO THE CUPBOARD

Use the 3,5 x 45 screws which are in the mounting set to fix the cooker hood to the cupboard. Be sure that when you draw out the slide set that the front panel doesn't gad to the cupboard door. (Figure 3-3a)

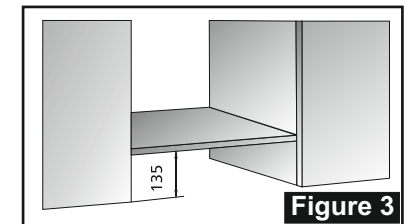

Figure 3

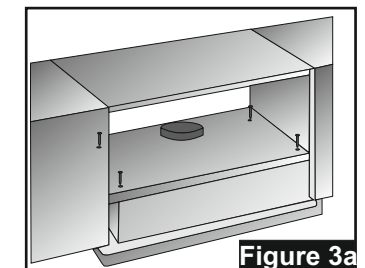

Figure 3a

### ATTACHING THE PLASTIC CHIMNEY:

Attache the plastic chimney wich is in your cooker hood.  
(Picture 3)



Picture 3

Provide an aluminum pipe and connect one end of this pipe to the plastic chimney of the device and the other end to the kitchen chimney. Check that these two connections are in a frequency not causing maximal cycle in the hood.  
(Picture 4)



Picture 4

Flections and bends at the aluminium pipe reduce the air absorbtion power, because of that use less flections and bends as possible.

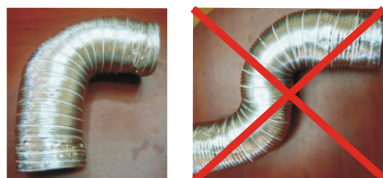

Correct

False

Picture 5

### Replacing the Lamps

Cut off the connection of the cooker hood with electricity. Take off the aluminum cassette filter. Take off the failed lamp and replace it with a new one that is of the same rating. (Please wait for the lamps to cool as they might hurt your hand.)

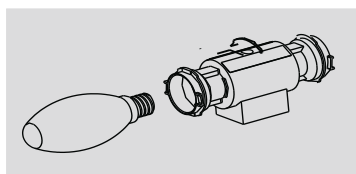

Figure 4

### USAGE TOUCH BUTTON

Remove protective foil on your inox product after installation.

**Speed Selection** The product has 3 ventilation speed choice. Ventilation speed is selected in accordance with steam of cooking or fry. You may switch on your product by pressing control buttons on the front panel. Automatic timer (TIMER) is available at all models with electronic control. When pressed on any of the motor control buttons for more than 2 seconds, timer function will be set for 15 minutes. When the timer is on, Display will signal and the motor will be off automatically in 15 minutes. Please use the cooker and the product at the same time to enable air circulation. This will have positive effect on air suction power. We recommend you to operate your product for few minutes more after the cooking is completed to enable absorption rest of smell and steam.

### TOUCH BUTTON POSITIONS

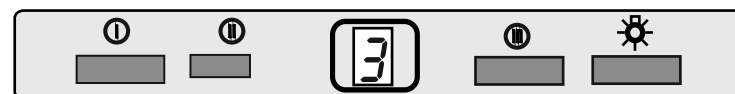

### Illumination

The product has 2 lamps and one lamp button to operate illumination. Press lamp button in order to start illumination.

### Efficient Ventilation

In order to ensure correct ventilation, keep your kitchen windows closed.

### IMPORTANT NOTE

Please pay attention when the product is operated at the same time with a product which operates using air and fuel (for instance; heater, water heater etc. which operates using gas, diesel fuel, coal or wood), since cooker hood may affect burning negatively as it directs the air out.

**This warning is not valid for usage without chimney.**

### TECHNICAL SPECIFICATIONS

Feeding Voltage	220-240 V 50Hz
Motor Isolation Class	F
Isolation Class	CLASS I

## USAGE ROCKER BUTTON

### Speed Selection 2 or 3

The product has 3 or 2 ventilation speed choice. Ventilation speed is selected in accordance with steam of cooking or fry. You may switch on your product by pressing control buttons on right side of the front panel. The motor begins to work when you draw out the slide set and when you draw it in it ends (it is an optional option).

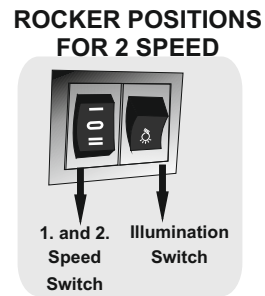
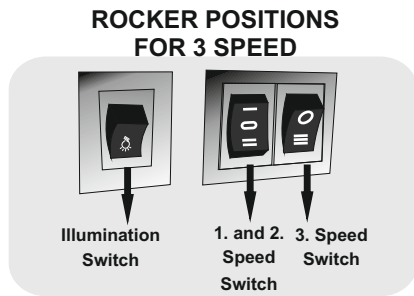

### Illumination

The product has 1 or 2 lamps and a lamp button to operate illumination. The slide set must be drawn out to start the illumination.

### Replacing 50W Halogen Lamp

In order to change halogen lamps, take the lamp downwards pushing back of lamp holder downwards and then turning it a little bit anti-clockwise take it off downwards. **Figure 5**

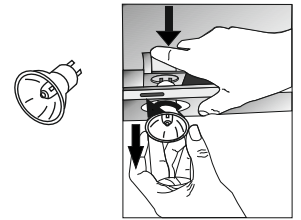

**Figure 5**

### Functions of the Product

Your hood is compatible for use with or without chimney.

#### Usage with chimney

The product should be connected to a chimney that will direct the air out during usage with chimney. In order to achieve best performance, pay attention that the duct system follows the shortest way for connection to the chimney. Your product is produced as it will be appropriate for usage with chimney.

#### Attention!!!

**Outlet of the product should not be connected to air canals that have other smoke as well.**

#### Active Carbon Filter

To provide air recirculation where product's chimney air outlet cannot be connected to exterior, it is necessary to use active carbon filter with your product. You may purchase this accessory from authorized sellers and after sales services.

#### Carbon Filter Usage

Your product is compatible with two types of carbon filters.

You may see following information on how to use carbon filters.

Before installing or replacing carbon filter, first you should cut your product's power off. Carbon filters should be replaced with a new one each 3-5 months because it is used at kitchens that does not have chimney outlet. Carbon filter should never be washed. Grease filters should be installed on the product even when carbon filter is not in use. Do not use your product without grease filter.

#### Replacing Carbon Filter

It is necessary to install 2 carbon filters to your product.

To place the carbon filter, place your filter on connection channels on motor and turn it clockwise.

In order to remove filter, turn it anti-clockwise. Figure 6-6a

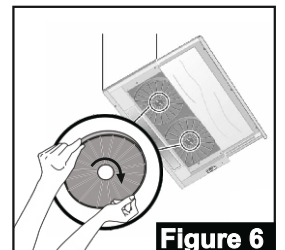

**Figure 6**

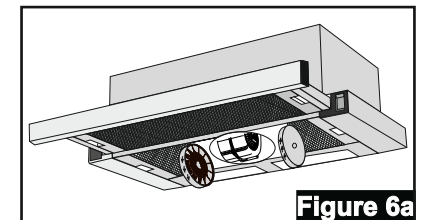

**Figure 6a**

## MAINTENANCE

\*Disconnect electricity connection before maintenance and cleaning process.

\*Aluminum cassette filter holds the dust and the oil in the air.

\*Metal filter should be washed once in a month with hot and soaped water or, if possible, at dishwasher (60C).

\*Take off aluminum cassette filter pressing on springy latches on end point. After cleaning, do not replace before it dries.

\*Outer surface of the cooker hood should be wiped with a wet cloth that is wetted with water or alcohol.

\*Please avoid contact of electronic parts with water or similar materials.

\*Using Inox cleaning and maintenance products available in the market will help your product to perform longer.

**Warning:** Aluminum filters may be washed in the dishwasher. Color of aluminum filters may change after several washings. This is normal and it is not necessary to change the filters.

## Efficient Ventilation

In order to ensure correct ventilation, keep your kitchen windows closed.

### IMPORTANT NOTE

Please pay attention when the product is operated at the same time with a product which operates using air and fuel (for instance; heater, water heater etc. which operates using gas, diesel fuel, coal or wood), since cooker hood may affect burning negatively as it directs the air out.

**This warning is not valid for usage without chimney.**

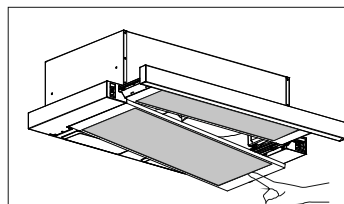

**Picture 7**

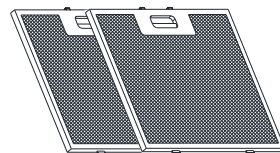

**Washable Aluminum  
Cassette Filter**

**Picture 6**

	Check electric connection (Voltage of the electric network should be between 220-240V) cooker hood should be connected to grounded	Check motor switch (Motor switch should be at on position)	Check motor switch (Motor switch should be at on position)	Check aluminum filter (Aluminum Cassette Filter should be washed once a month at normal conditions.)	Check lamps (Lamps should be firm.)	Check outlet (Outlet should be open)	Check Carbon Filter (Carbon filter should be replaced with a new one each 2,3 months at the models with Carbon Filter at normal conditions)
Cooker-hood does not work	✓	✓					
Illumination Lamp does not work	✓		✓		✓		
Cooker-hoods air suction is weak				✓		✓	✓
Cooker-hood does not direct air out (at places without chimney)				✓			✓

**If the product does not work:**

**Before you contact the technical service:**

Make sure that the product is plugged in and the electric fuse of the electric wiring is running. Do not take any action that will damage the product. Before you contact with technical service, check your cooker hood according to Table 1. If the problem goes on, contact the seller or the most authorized service.

Please use the cooker and the product at the same time to enable air circulation. This will have positive effect on air suction power. We recommend you to operate your product for few minutes more after the cooking is completed to enable absorption rest of smell and steam.