

cooking collection

Instructions for use and warranty details

Built In Oven
Model No.: OMF6022

 **kLEENmaid**

Dear Customer,

Thank you and congratulations for choosing Kleenmaid.

Your new appliance has been designed and meticulously tested to ensure that it meets all your culinary requirements, and has been carefully manufactured using top quality materials to give you years of reliable performance.

For best results, carefully read the instructions on how your new appliance is to be installed. Correct installation will avoid delays and unnecessary service call costs.

Once installation is complete, please read this instruction manual carefully and get to know the controls and the features of your new Kleenmaid appliance. These simple instructions will enable you to achieve excellent results from the very first time you use it.

Again, congratulations and thank you for choosing The Best You Can Own.

KLEENMAID

GENERAL WARNINGS

This product is in compliance with the EU 2002/96/EEC Directive.

The crossed out “wheeled bin” symbol on the appliance indicates that at the end of its life-span, the product, as it has to be separately treated from domestic waste, must be conferred to a differential collection centre for electric and electronic appliances or redelivered to the dealer at the time of purchasing a new equivalent appliance.

The user is responsible, at the time of disposal, for taking the device to the appropriate collection point. Failure to do so shall result in punishment in accordance with the current legislation on waste disposal.

Proper differentiated collection is necessary so that the obsolete device can be sent on for environmentally friendly recycling, treatment and dismantling, in order to avoid any possible negative environmental impact or health risk and to permit re-use of the constituent materials.

More detailed information about available systems for collection may be obtained from the local waste disposal services, or from the shop where the device was purchased.

The manufacturer declines all civil or criminal liability in the event of poor or improper installation of the device.

The manufacturer also reserves the right to make any necessary and useful amendments to its products without prior notice.

Dispose of the various packaging materials in compliance with the applicable local Standards.

Carefully read this instruction manual prior to installing or using this device, in order to have all the necessary information for correct installation, maintenance and use of the same.

It is essential for this instruction manual to be kept together with the device for its entire life-span, also in case of transfer to other persons.

This appliance has been designed for domestic use and only for the cooking and heating of food. Any other use, different to that indicated in this manual must be considered improper and consequently dangerous.

The product is in compliance with the 89/109/EEC European Directive as it is destined to come into contact with food products.

This household appliance is compliant with the provisions of the European Community Directives

- **LOW VOLTAGE DIRECTIVE – 2006/95/EC**
- **ELECTROMAGNETIC COMPATIBILITY DIRECTIVE – 2004/108/EC**

The product identification data is stated on the relevant plate applied on the front of the oven. **The plate must never be removed.**

Installation must only be carried out by qualified staff in compliance with the local regulations in force

and following the indications in this manual.

Important: do not lift or pull the oven with your hands.

In case of malfunctioning, disconnect the appliance from the electric mains (do not pull the power supply cable to disconnect the plug) and contact the authorised original spare parts technical after-sales centre.

Do not, in any case, attempt to repair the device.

Correct use of the oven

- This appliance is not intended for use by persons (including children) with reduced physical, sensory or mental capabilities, or lack of experience and knowledge, unless they have been given supervision or instruction concerning use of the appliance by a person responsible for their safety.
- Children should be supervised to ensure they do not play with the appliance. - The use of the device is only intended for adults, keep children out of reach
- The appliance produces heat both in the functioning phase and due to inertia, even when just turned off. Do not touch parts inside the oven during these phases and limit contact with the external parts. Keep children away from the appliance when operating. The accessible parts can become very hot.
- To insert or extract containers or accessories from the oven, always use suitable protective gloves.
- Use only containers able to resist to high temperatures
- Do not leave the appliance unattended during cooking operations that may release greases or oils that may catch fire.
- Never cover the walls or lower part of the oven with sheets of aluminium foil or other objects such as pans or trays. This could damage the oven.
- Do not use the oven to store objects when it is not in use, otherwise damage could be caused to both the oven and the objects when the appliance is switched on.
- Do not sit on or place weight on the open door and do not hang weights on the handle as to do so could damage the product and cause malfunctions.
- Before maintenance or cleaning, isolate the power supply from the oven and, if just used, wait for it to cool.
- Pay attention to the flow of air that leaves the oven when the door is opened when the same is hot.
- Do not use jets of steam for cleaning, which could reach and damage electrical parts.
- If the supply cord is damaged, it must be replaced by the manufacturer, its service agent or similarly qualified persons in order to avoid a hazard. **Attention, this appliance must be earthed in compliance with the standards in force.**

For installation of the oven see the “installation instructions” chapter

Correct use of the oven

- Pre-heat the oven for the strictly necessary time only
- Open the door only when necessary to avoid unnecessary heat losses
- Keep the gaskets clean and efficient to avoid heat dispersion which can cause damage
- Always turn off the oven when no longer in use
- To reduce the formation of condensate owing to the humidity in food, it is always necessary to pre-heat the oven before introducing the foodstuffs. However formation of condensate on the door glass or on the walls of the oven does not compromise its functioning and will tend to disappear with the cooking.

Prior to oven commissioning:

Disconnect the power from the appliance.

*Remove all internal packaging and accessories from the oven, **including protective blue film**. Clean the internal surfaces with hot water or neutral detergent (see “maintenance and cleaning”). Rinse thoroughly with a damp cloth. Wash all oven accessories in the same way and dry everything thoroughly.*

Attention:

- Never use this device to warm the premises
- Do not obstruct the passage of cooling air by blocking the ventilation holes of the room and ducts on the appliance.
- Before installation, check that the local power supply is compatible with the data indicated on the product label.
- During use, do not touch the heating elements inside the oven.
- The accessible parts can become very hot during use, it is recommended to keep children out of reach.

Contents

User instructions,	6
First use,	6
Control panel,	6
Instructions for use:	
– grill cooking,	6
– conventional cooking,	8
– fan cooking,	8
– defrosting,	8
Timer touch control,	9
Adjust of the temperature,	9
Manual functioning,	9
Cooking pause,	9
Semi-automatic functioning,	9
Automatic functioning,	9
Timer function,	9
Alarm function,	9
Meat probe function,	9
Boost function,	9
Display of the temperature,	11
Acoustic Signal,	11
Tones of the controls,	11
Clock reading mode,	11
Energy saving option,	11
Safety for children,	11
Error codes,	11
Light replacement,	12
Removing the oven door,	12
Installation instructions,	16
Electrical connections,	16

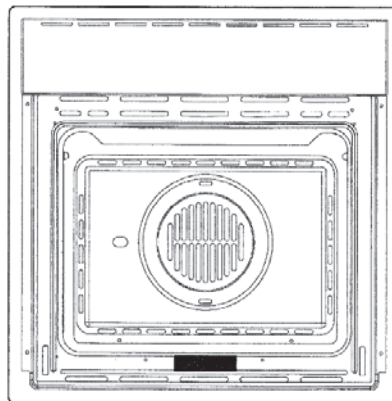

IMPORTANT

The oven's data plate is accessible even with the oven fully installed. The plate is visible simply by opening the door. Always quote the details from it to identify the appliance when ordering spare parts.

User instructions

Important:

Before using the oven for the first time, allow it to operate empty and at maximum temperature for about 1 hour. Ventilate the room well, possibly by opening the windows. This will allow evacuation of the combustion fumes of manufacturing residues such as grease, oil and resin.

Control panel

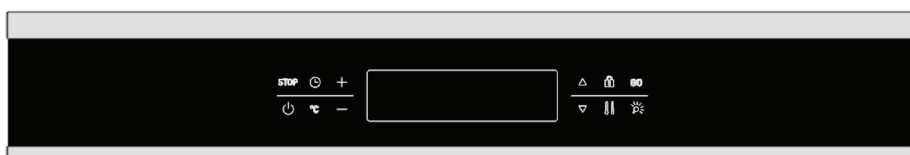

Control Panel Functions

- | | | | |
|---|------------------------|---|----------------------------------|
|  | = On/Off |  | = Scroll Down Values |
|  | = Start Programme |  | = Scroll Up Values |
|  | = Stop/Pause Programme |  | = Activate Boost (quick heating) |
|  | = Adjust Temperature |  | = Adjust Time |
|  | = Increase Number |  | = Light On/Off |
|  | = Decrease Number |  | = Safety Lock On/Off |

This programmer has touch sensors which are used by pressing lightly in the area indicated by the symbols

Instructions for use

This appliance is provided with a tangential fan for cooling the control panel and the oven door handle. This fan starts working a few minutes after the start of cooking, when the oven reaches a certain temperature (the time varies according to ambient conditions and oven settings) and also avoids overheating of the cabinet housing. Hot air will continue to be expelled below the control panel after the oven is switched off, and until the temperature of the oven falls to a normal level.

POSITION OF THE INTERNAL GRILLS FOR SPECIFIC FOODS

Frozen cakes, Long roasts, Turkey, Cakes, Meat Steak well done: Position n. 1 and 2 from bottom

Cakes, Sandwich Load, Toast, Casserole, Wholemeal bread, Meat: Position n. 2 from bottom.

Biscuits, Fine cut meat: Position n. 2 and 3 from bottom.

For Browning with Grill: Position n. 3 from bottom.

These cooking positions are indicative and can be changed on the basis of your own experience.

USING THE GRILL

To optimise Grill cooking, switch on the grill oven and pre-heat for at least 10 minutes. Introduce the dish inside the oven in the nearest position to the Grill, depending on the type of food to cook. The grill should only be used on each dish for a maximum of 15 minutes at a time.













With the grill it is possible to cook fish, vegetables and various types of meat, with the exception of lean game meat. Finely cut meat and fish must always be grilled very quickly greasing slightly with oil using a suitable brush and always placed on the grill. In turn, the grill must be placed nearest to the upper heating element, proportionally to the thickness of the dish, to avoid burning it on the surface and not cooking it enough inside. Only salt the meat after cooking or it will be less juicy. Never prick food during cooking, not even to turn it.

Meat can be arranged in suitable heat-proof containers or cooked directly on the grill. In the latter case, always pour some water in the drip pan then insert it in the guides under the grill. This prevents the grease in the dripping pan from burning and creating bad odours.

Attention: during use of the Grill, the accessible parts can become extremely hot. It is therefore advisable to keep children at a safe distance.

Never prick food during cooking, not even to turn it. The juice would be released, making the grilled food dry.

Cooking Function Overview

 = Top & Bottom Heating Elements	 = Pizza And Bread
 = Bottom Heating Element	 = Intensive Cooking
 = Top Heating Element	 = Circular Heating Element With Fan
 = Grill Element	 = Defrost Fan
 = Double Grill	 = Food Warmer
 = Ventilated Grill	 = Meat Probe
 = Boost	

SETTING THE TIME

Upon first connection to the power the flashing digits 0:00 appear on the display, and it is not possible to use the oven without first setting the time. To adjust the time press symbols + and - one step at a time, or press either symbol continuously to increase speed of incrementing or decrementing the digits. After about 7 seconds of not pressing either of the symbols, the displayed time is accepted and the digits stop flashing. In case of temporary power disconnection, the clock remains set for about 45 seconds.

To amend the time, simultaneously press and hold the symbols + and - until the digits start flashing, then use these symbols as described above to make the desired change.

Using the cooking functions



The oven light can be turned on independently at any time. The light also stays on with cooking functions.



Traditional static cooking + CLEAN FUNCTION

With the simultaneous heat distribution coming from above and below, this function is for baking food that requires slow cooking with the constant addition of liquids. Ideal for any type of roast, bread, cakes and biscuits in general. Use only one shelf for this type of cooking, otherwise the temperature will not be distributed properly.



Lower cooking

In this case the bottom heating element starts working. Unlike cooking with the upper cooking method, this function is recommended for perfecting the cooking of dishes that are already cooked on the surface but require further cooking in the centre. The intense heat from below is excellent for roasting meat which is not so tender.



Upper cooking

This function activates the heat element at the top. The intense heat diffused from above is excellent for finishing off the baking of food that is cooked on the inside but not entirely on the surface.



Grill

Use the grill to brown foods.



Double grill

Use the double grill to brown foods more quickly. Especially suitable for thinly sliced foods to be browned quickly.



Ventilated electric grill

This function permits grilling in a softer manner thanks to the use of forced air. Forced circulation of air inside the oven increases heat penetration in food and prevents burning on the surface. Consult the "Use of the Grill" paragraph.



Pizza & bread

This function is for baking and browning pizza and bread.



Intensive cooking

The activation of the top and bottom heat elements together with the fan ensures even distribution of the intense heat produced. The hot air circulating inside the oven evenly cooks and browns, on one or more levels, different dishes requiring similar temperatures. In meat roasts the optimised heat distribution allows cooking at lower temperatures which reduces the loss of juices. This helps to keep the meat tender and minimises any decrease in weight.



Ventilated cooking

This function allows differing types of foods to be placed on several levels without mixing their flavours, and the evenly circulated hot air allows even baking.



Defrost

Only the fan is functioning without any heating element. This function can be used to defrost and/or dry the food to be cooked, only with the movement of air circulating at ambient temperature. This permits the defrosting of dishes without altering their taste or appearance.



Food warmer

Use this function to keep already cooked food warm ready for serving for up to 30 minutes.

















Meat probe

This function uses the supplied meat probe to automatically cook meat until the set temperature is reached at the core of the food. See "Meat probe function" on page 10 of this manual for more detailed instructions.



Timer touch control

Control Panel Functions

-  = On/Off
-  = Start Programme
-  = Stop/Pause Programme
-  = Adjust Temperature
-  = Increase Number
-  = Decrease Number
-  = Scroll Down Values
-  = Scroll Up Values
-  = Activate Boost (quick heating)
-  = Adjust Time
-  = Light On/Off
-  = Safety Lock On/Off

It is possible to scroll the oven functions menus by pressing the   symbols. The current function will flash for a few seconds and the set temperature assigned to the function will appear (certain functions do not envision the adjustment of the temperature, in this case no value appears). The symbol  and flashing writing **PAUSE**, indicate the oven is ready for cooking in the chosen function but cooking has not yet started.

Adjusting the default temperature assigned to a function

To amend the temperatures defined automatically for each function, slightly press symbol  and act on **+** and **-** adjusting the temperature with 5°C intervals. After a few seconds the new value is set and stops flashing. Press  for cooking to start again.

To go back to the pre-set temperature, repeat the procedure or exit and access the function again.

Once definitively changed the temperature set by the manufacturer, press symbol until a warning beep is emitted (about 5 seconds) and the temperature digits stop flashing.



Manual functioning

Once the function is selected, act on  to start cooking; the display will show the set temperature. The **PAUSE** symbol disappears and the timer starts indicating the time past from cooking start. Cooking will continue until manually interrupted (see entries “cooking pause/start/end”) or has reached the maximum limit pre-set by the manufacturer. The maximum achievable cooking time limit varies depending on the temperature set in the following values:

For temperatures: **from 50 – 120°C max time 10h; from 121 – 200°C max time 6h; from 201 – 250°C max time 3h.**

In semi-automatic and automatic cooking, as described further below, cooking is automatically interrupted as from previously set parameters.



Cooking pause, amendment or end functions

Pressing on  during cooking interrupts the same and the symbol **PAUSE** starts flashing. All oven elements are temporarily disabled. All display indications disappear by touching  again. The display will indicate the *temperature status* (see entry “**Temperature displays**”). Pressing  once, the last interrupted setting appears again, and pressing it a second time, starts cooking again.



To amend the parameters (functions, temperatures, etc.) follow the above indications, pressing  at the end to confirm.

Semi-automatic functioning (with cooking time duration set)

This function allows programming the wanted cooking end time with immediate start of the same, setting the wanted cooking duration time. In this case it is not possible to use the food probe.

To activate semi-automatic functioning, select the wanted oven function from the menu and, eventually, adjust the cooking temperature as previously described. Slightly touch symbol , the digits **0:00** of the timer will start to flash. Adjust the wanted cooking duration time (the symbol **AUTO** appears) and press , cooking starts immediately and the display will show the time it will end, as set by you.

An acoustic signal will warn of cooking end, press  to interrupt the acoustic signal. It is possible, at any moment, to vary the time and temperature function parameters set as previously described.

Press  to interrupt cooking, the writing **PAUSE** appears, press  a second time to cancel the program. *In this situation it is not possible to use the meat probe.*

Semi-automatic functioning (with cooking time end set)

In this case, it is possible to set the wanted cooking time end with immediate start, without indicating its duration. *As for previous function, in this situation it is not possible to use the meat probe.*

To activate cooking end, select the wanted oven function from the menu and, eventually, adjust the cooking temperature as previously described. Press symbol \odot twice; the cooking end time corresponding to the time of the day appears. Press on $+$ or $-$ to program the wanted cooking end time. Press on \square_{GO} , the **PAUSE** symbol stops flashing and the oven starts cooking. Press \square_{STOP} to interrupt cooking, the writing **PAUSE** appears, press \square_{STOP} a second time to cancel the program.

Automatic functioning (with delayed start)

This function allows programming the cooking duration, also setting the start time. To be used in case of wanting a programmed start. In this case also it is not possible to use the food probe (where envisioned).

To activate automatic functioning, select the wanted oven function from the menu and, eventually, adjust the cooking temperature as previously described. Slightly touch symbol \odot , the digits **0:00** of the timer will start to flash. Adjust the wanted cooking duration time (the symbol **AUTO** appears). Press symbol \odot again, the cooking end time envisioned by the entered duration time flashes, act on $+$ and $-$ to set the wanted cooking end time. Press (**GO**) to activate programming. The oven is now in stand-by and will start when set by you. The function, temperature and cooking end time will appear on the display. The flashing of an arrow near the temperature will indicate cooking has started. A acoustic signal will warn of cooking end, press \square_{STOP} to interrupt the acoustic signal. It is possible, at any moment, to vary the time and temperature function parameters set as previously described.

Example: it is 11:30, the cooking time necessary is 30 minutes and cooking must end at 13:00 by setting it in the program. The oven will switch on at 12:30 and switch off at 13:00.

Press \square_{STOP} to interrupt cooking, the writing **PAUSE** appears, press \square_{STOP} a second time to cancel the program.

Timer function

With this function it is possible to activate a timer signalling when the set time has ended.

Repeatedly press symbol \odot , until the symbol \triangle appears flashing together with the digits 0:00 of the timer. Adjust the wanted minutes by acting on $+$ and $-$. The digits will stop flashing after about 7 seconds. After the set time has past, an acoustic signal lasting about 7 minutes will warn the time has expired. To stop the acoustic signal act either on $+$ or $-$. This function can be used for manual cooking.

Alarm function

This function allows programming a buzzer at a wanted time.

Repeatedly press symbol \odot until the symbol 🔔 appears flashing, together with the time of the day. Now, using $+$ and $-$ adjust the time of the day when wanting the alarm to sound. The digits will stop flashing after about 7 seconds. After the set time has past, an acoustic signal lasting about 7 minutes will warn the time has expired. To stop the acoustic signal press either $+$ or $-$.

Guide to Meat Probe Temperature		
Type of Meat	Taste	'C
Beef	Well Done	77
	Medium	71
	Medium-Rare	63
Veal	Well Done	77
	Medium	71
Lamb	Well Done	77
	Medium	71
	Medium-Rare	63
Pork	Well Done	77
	Medium	71
Chicken	Well Done	82
Turkey	Well Done	82

Meat probe function

The Meat Probe is a sensor which may be connected to the socket inside the oven and directly inserted in the food to be cooked. The oven can automatically stop cooking when the food reaches the desired temperature at the location of the probe. *The probe must be inserted into the food such that the tip is located as near as possible to the centre of the food without touching the bone.*



To activate it, select the desired function and, if necessary, change the temperature that appears by default (see the section **“Adjusting the default temperature assigned to a function”**). Now press the key \odot . The default programmed temperature value for the probe flashes in the two digits to the right of the timer

(with this function, the timer display is used to display the temperature of the core probe). The word **AUTO** also appears. Set the desired core temperature for the dish between 20/99°C by the buttons $+$ or $-$.

Press the key **GO**, the word **PAUSE** goes off and the cooking commences. The current temperature is visible by the digits on the left while the temperature you set is shown on the right-hand digits of the timer display.

Boost function

This function allows you to speed up the oven preheating stage.

After choosing the desired cooking function, press button . The most appropriate elements activate to quickly reach the set temperature and on the display the symbol  will be visible and will disappear as soon as the temperature is reached. The program will also sound a buzzer to alert you. At this point the system will activate the functions previously set.

The quick heating cannot be activated: with the **GRILL** function, when the difference between the set temperature and the target temperature is less than 50°C and when the target temperature is less than 100°C.

Temperature displays

The 5 bars near the set temperature indicator show the temperature level reached by lighting up as the temperature increases. The nearby flashing upward arrow signals the oven is warming. After cooking is automatically or manually interrupted, with the temperature inside the oven above 60°C, the flashing downward arrow and the writing **hot** will appear on the display until the oven temperature drops below 60°C.

Acoustic Signal

The acoustic signal continues at the end of a program for about 7 minutes. To interrupt it press **+** or **-**. The intensity of the signal can be regulated on three different sound levels in the following way: in **STOP** position, act on symbol **-** keeping it pressed for about 5 seconds until the currently set tone level appears (**tn1 high – tn2 medium – tn3 low**). Again act on symbol **-** to set the wanted level. The previous screen returns after a few seconds.



Tones of the controls

It is possible to amend the type of sound emitted when acting on the controls. In **STOP** position, keep symbol **+** pressed for about 5 seconds. Again act on symbol **+** to choose “**bt**” (beep tone), “**c**” (click tone) or “**nt**” (no tone).



Clock reading mode

The basic programming envisions reading of the time in 24 hours. To display the time in 12 hours am/pm, keep **+** and **-** pressed simultaneously for about 5 seconds. The new setting will appear on the display.

Energy saving option

To limit electric energy waste to a minimum, you may use the **PS** (Power Save) function. Once activated, this function switches the oven off completely and, without cooking functions activated, no intervention can be made with any control. Keep the symbol  pressed for about 5 seconds, the writing **PS on** will appear. The function is now activated and the oven will automatically switch-off after about 1 minute. To switch it on, act on symbol . To go back to previous situation, repeat the operation (basic programming is set on PS OFF)..

Safety Lock

This function allows you to block access to the functionality of the keys both when the oven is running and as a prevention with the oven is off. By touching the  symbol for about 2 seconds, this function is activated, (the  symbol is displayed). This prevents children or other persons from touching the programmer symbols accidentally and thus modifying the previous program or starting the oven. Touch the  symbol again for about 2 seconds to deactivate it. Any programmer signal that occurs during oven operation when the safety lock is activated can be cancelled by touching any of the boxed control panel symbols. The Safety Lock will remain active after this operation. NOTE: The Safety Lock must be deactivated in order to change programme settings.

Errors codes

When situations preventing the normal functioning of the oven occur, the device warns with a series of errors signals, which:

Err1: communication error – Err2: PT1000 (probe) open circuit – Err3: PT1000 (probe) closed circuit – Err4: temperature on display too high – Err5: Temperature on the power board too high – Err6: fault on the display – Err7: fault in the power board – Err8: no heating is detected.

For errors **Err4 and Err5**, switch-off the oven and leave it to cool down for a few hours, then try working it again. If the error persists, call the after-sales technical assistance. **If any other errors occur, advise an authorised after-sales technical representative.**

Replacing the oven light

To prevent electric shocks and/or damage to persons, read and follow the procedure given below:

WARNING: Ensure that the appliance is switched off before replacing the lamp to avoid the possibility of electric shock.

Ensure that the oven and the light bulb are cold and then remove the protection cover A

Do not touch the hot bulb with a damp cloth, the bulb may break.





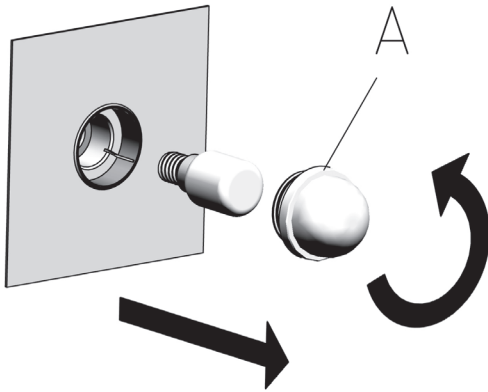



Replace the light bulb with another suitable one of 25 W for 220 - 230 V with attachment type E14 suitable for high temperatures.

In case the protection cap is damaged or broken, do not use the oven until the cap has been replaced or re-inserted correctly and safely.



Using the CLEAN function

This oven interior has a unique oleophobic (oil repellent) finish which allows assisted cleaning at much lower temperatures and energy consumption than in pyrolytic ovens. The CLEAN function may be used at any time the oven is not being used for cooking.

1. It is recommended for ease of cleaning but not required that the wire grills, trays, racks and rack holders be removed from the oven and stored in a safe location. If the oven is hot use a thick cloth or oven mitt to do this.
2. Set cooking function to  using  and , then press  and set the temperature to 250°C, using  and .
3. Press , set the duration to 30 minutes (0:30) and press  again. The CLEAN function will commence immediately.
4. When the acoustic signal sounds, press any key to silence it then open the oven and allow to cool for 15 minutes
5. Use a slightly damp cloth to wipe clean the enamel interior of the oven while still warm.
6. If they were removed, return the rack holders, racks, trays and wire grills to desired locations.

Instructions for removing and replacing the door

To remove

1. Open the oven door completely.
2. Insert a 3mm diameter metal rod (not supplied) through the holes in each hinge (see the diagram).
3. Close the oven door with the rods inserted.
4. Hold the door with a hand on each side and lift it up slightly and away from the oven, which will remove the hinges from the slots in the frame of the oven. Never lift the door by its handle.
5. Do not remove the rods from the hinges while the door is off the oven

To replace

1. Re-installation is the reverse of the above procedure.
2. Hold both sides of the door at the centre and insert the ends of the hinges into the slots in the oven frame.
3. Open the door completely and remove the rods from both hinges.
4. Close the door and make sure that it fits evenly against the door seal and is aligned with the side edges.

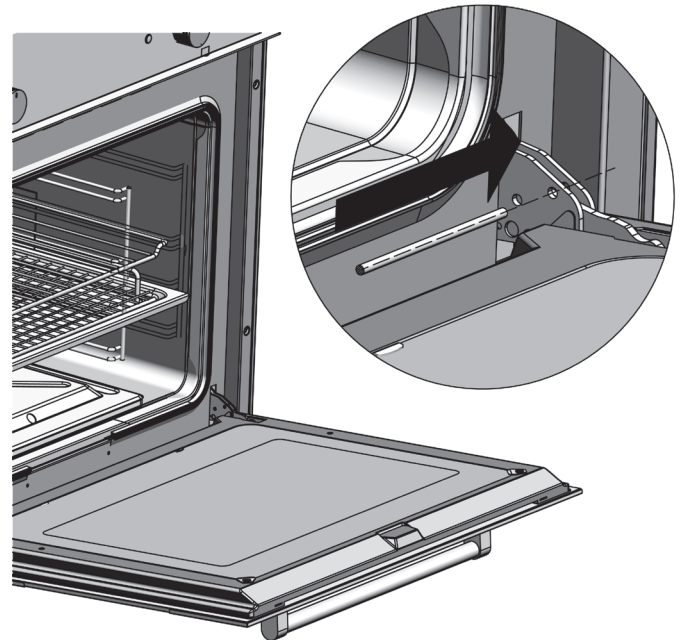

Removing the glass inside the oven door

General notes

To make it easier to clean the door, you can remove the glass inside it. To take it out, follow the instructions below.

Important: To remove the internal glass you need to remove the door from the oven (see paragraph on “Removing the oven door”) and place it on a steady surface that ensures the necessary steps are conducted safely.

Attention: Do not use any kind of blunt or sharp tool that may break the glass or damage the door.

Pay attention to which way you place the glass surfaces when you put them back, as they cannot be turned around. If they are not positioned correctly, this may affect the operation of the oven or even seriously damage the appliance.

Door model with profiles (remove the door from the oven)

For this door model, along with the outer glass, you can also take out the intermediate glass.

Remove the oven door, unscrew the 4 clamping screws of the steel plates C (fig. 5) that lock the glass surfaces into place. The glass surfaces can now be removed by slipping them out. Carry out the same steps in reverse order to place back the glass surfaces. Take the utmost care to ensure

they are in the right order and are placed the right way round (the clear glass must be towards the inside and the position of the lettering on the glass surfaces must be as in (fig. 6). Also make sure the protective gaskets are positioned correctly. Some models have a glass anchoring clip that must be repositioned correctly (fig.7) by keeping the clip D against the painted strip on the upper part of the door and inserting the intermediate glass E and inner glass F into place (as shown in the figure)

Before re-installing the door, make sure the glass is firmly secured into place

CAUTION! THE REMOVAL AND INSTALLATION MUST BE CARRIED OUT ACCURATELY AND WITH THE HIGHEST CARE IN ORDER TO AVOID BREAKING OF THE GLASS

Attention: Do not remove the hinge locking hooks from their seat when the door is not mounted in the oven. Do not close the hinges without the weight of the door as it causes a violent closing of the springs.

Do not rest weights on the door and do not hang them on the handle, they might damage the product and cause malfunctioning. Moreover, do not use the oven until the oven door has been re-mounted correctly.

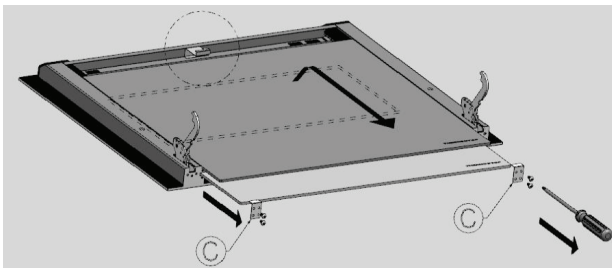

fig. 5

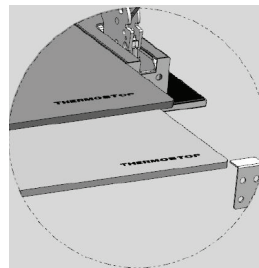

fig. 6

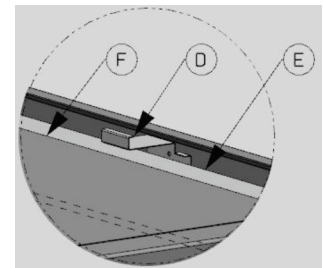

fig. 7

Maintenance and cleaning

Disconnect the electric power supply before performing any type of maintenance on the product

Do not clean the device with steam cleaners.

Do not use rough, abrasive materials or sharp metal scrapers to clean the oven door, as they can scratch or damage the surfaces and cause the glass to break. Do not use acid products (like anti-scaling agents) as they can damage the enamelled parts.

Turn off the heating elements, wait for the internal parts of the oven to cool down before touching or cleaning them.

Pay greater attention to the cooking grills. Clean the oven with care. When cleaning with a wet sponge or soft cloth, take all due care if the surface is hot as it will produce steam and you will risk scalding yourself. Moreover, some detergents create noxious fumes on contact with the heat.

Periodic maintenance

Regularly check the state of the rubber gasket located around the oven opening. It guarantees the correct functioning of the oven. If gasket damage is noted, contact the nearest technical after-sales centre.

Cleaning the surfaces

The enamelled or stainless steel parts must be treated with caution. Use water or specific products, accurately drying with a soft cloth. **Do not use abrasive products.** In case of tough deposits on enamelled parts, use a plastic sponge or similar, soaked in hot water and vinegar. It can become very difficult to remove food residues or stains from oils, sugars, fats, etc. if they are not immediately removed after use of the oven. It will make removing them easier if the internal parts of the oven are cleaned while they are still warm.

Due to an increasing presence of new products on the market it is not possible to establish a list of items suitable for cleaning this device. Read the manufacturer instructions carefully to verify the possible use of the detergent.

Removing/mounting the lateral guides

Proceed as follows to release the lateral guides:

Take the guide by lifting it up at the front and pull it towards the inside of the oven (**fig.1**) so that the guide's hook comes out from the slot on the oven's wall.

Now pull the guide towards you and lift it by taking it out from its housing at the back (**fig.2**).

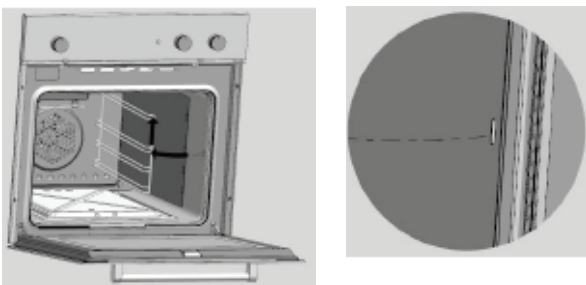

fig. 1

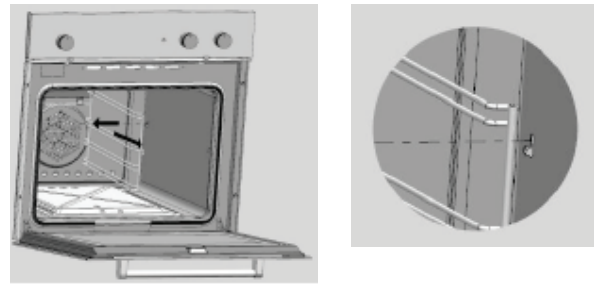

fig. 2

To place back the guides, carry out the steps in reverse order. Always make sure you do not damage the enamel on the oven's walls.

Removing/mounting the sliding guides

There are right and left sliding guides, which means they are not interchangeable between the two sides of the oven.

Proceed as follows to remove the sliding element from the lateral guide:

Release the lateral guide from the oven together with the sliding element, as reported in the paragraph above.

Place the guide on a flat surface. Now exert some pressure from top down near the couplings in the sliding element (**fig. 3 step 1**). When the couplings underneath come out from the rod of the lateral guide, the sliding element has been released and can be removed. (**fig. 3 step 2**).

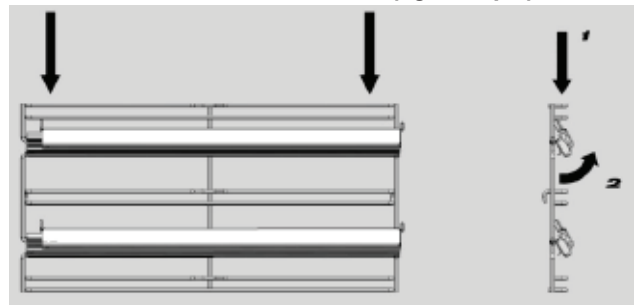

fig. 3

To place back the sliding element, position the upper hooks on the special rods of the lateral guide. Always make sure the sliding element is moving towards the outside of the oven when it is taken out. Now press the sliding element downwards (**fig. 4 step 1**) so that it is coupled onto the lower rods (**fig.4 step 2**).

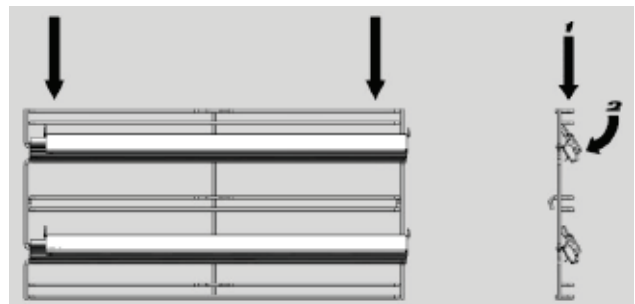

fig. 4

Drip pan insertion (removable guide rails version)

CAUTION use specific hand protection devices if these operations are performed with a hot oven, as the drip pan can be very hot.

With the sliding guides fully inside the oven, insert the drip pan by making the rear side rest at approximately half the length of the slides, and keeping its front slightly lifted (fig.1p).

In this position, push the drip pan until the guide rear end stop is reached; now, put into place the entire drip pan (fig.2p).

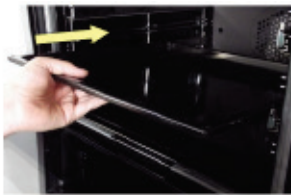

Fig.1p



Fig.2p



Fig.3p

Make sure that the holes of the drip pan front are placed inside the end stops of the sliding guide (fig.3p).

To remove the drip pan, pull it towards you and leave it on the side sliding guides until they are fully removed; then, lift it by holding it firmly.

GRILL INSERTION

CAUTION use specific hand protection devices if these operations are performed with a hot oven, as the grill can be very hot.

With the sliding guide rails fully inside the oven, insert the grill by making its rear (side with the rear rod) rest at approximately half the length of the guide rails, and keeping its front slightly lifted (fig.1g).

In this position, push the grill in until the rear end stop is reached; now, put into place the entire grill (fig.2g).



Fig.1g



Fig.2g

Make sure that the grill front is placed inside the end stops of the sliding guide rail (fig.3g).



Fig.3g

To remove the grill pan, pull it towards you and leave it on the side sliding guides until they are fully removed; then, lift it by holding it firmly.

Installation instructions

The installation and technical assistance must only be performed by qualified staff. Carefully read the safety instructions in this manual before using the oven. Incorrect installation, maintenance, assistance and use can cause serious damage/injury to persons or objects

This product must be installed as instructed in this manual and in compliance with National Standards and local regulations in force.

Do not lift or pull the oven from the door handle and do not force or load weights when this is open.

The purchaser is responsible for installation. Assistance provided by the manufacturer due to incorrect installation is excluded from the warranty.

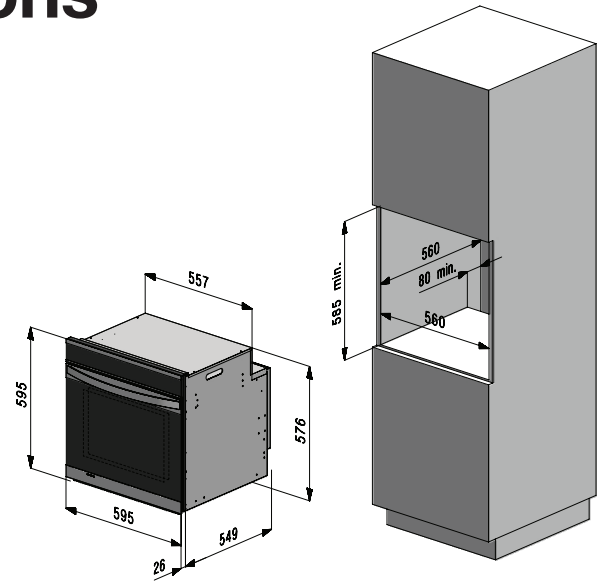

Features of the cabinet

The technical requisites of the cabinet are the following;

- The cabinet and its components must be able to withstand temperatures of up to 90°C without presenting deformities and/or surface defects.
- The cabinet must enable the free passage of the oven connections.
- All household kitchen units must be protected with fire-resistant material in accordance with the standards in force.

Inserting the oven in the cabinet

It is important that all operations relating to installation of the device are carried out by qualified staff. The oven can be installed in a column or below the worktop of a kitchen cabinet.

Built-in measurements

The dimensions of the opening to be made in the cabinet for fitting the oven are indicated in figures. Ensure that the cabinet where the oven is to be installed, is able to support the weight of 30 kg. For the opening in the cabinet follow the dimensions in the respective figure.

It is necessary to create an opening in the rear part of the bottom of the cabinet or in the oven support shelf, to allow sufficient air to circulate for the cooling of the oven during functioning.

Ensure the oven is safely installed inside the cabinet. Use screws to fix the oven to the front face of the cabinet.

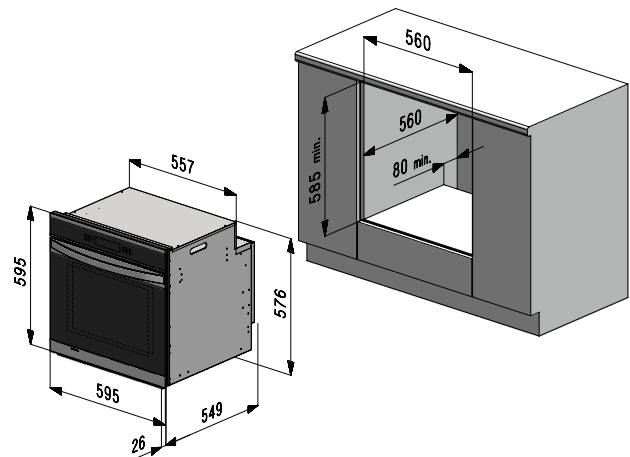

Electric connection of the oven

FIXED WIRING:

Ensure the electric current has been disconnected before connecting the oven to the electric mains.

The oven requires single-phase alternate current 220-230-240 V~ 50-60 Hz, using flexible cable. Ensure the household power supply can support the electric load of the device. (see serial plate). The electric safety of this appliance is only assured if the same is correctly connected to a system having efficient earth connection, according to the legal Standards in force.

In case of permanent connection to the electric mains, apply a bipolar switch dimensioned to the corresponding load, with opening for each contact of at least 3 mm in accordance with the current local regulations.

The installer must ensure that the switch is suitable for the power absorbed by the oven as indicated on the serial plate.

The switch must be easily accessible. Disconnection of the appliance from the electrical supply by the user must be allowed for.

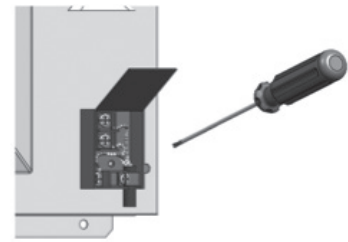
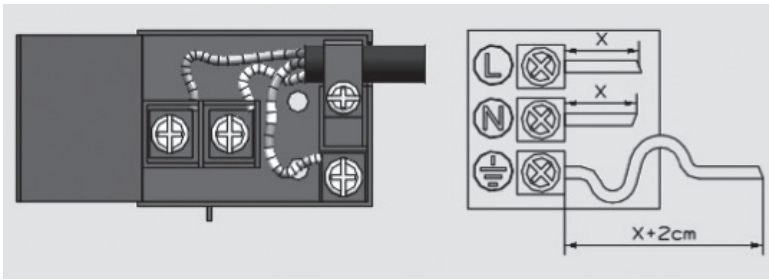

Assembly/replacement of the power supply cable

If the supply cord is damaged, it must be replaced by the manufacturer, its service agent or similarly qualified persons in order to avoid a hazard.

The electric cable must be kept locked to the terminal box by the cable fix, so that it cannot come out. Connect the line cable to terminal **L**, the neutral cable to terminal **N** and the yellow/green cable to the earth terminal \perp . The yellow/green cable must be longer than the other two by at least 20 mm.

Ensure the electric cable does not pass near or come into contact with the surfaces reaching a temperature above 75°C.

Earth connection

Installation, connection and earthing of the electric system must comply with the Australian standard requisites and meet the provisions of the local Standards in force.

This household appliance requires an earthing connection for protection against short-circuits or other electrical faults. It must, therefore, be connected via appropriate electric wiring and isolating switch.

ATTENTION:

DISCONNECT THE ELECTRIC POWER SUPPLY BEFORE PERFORMING TECHNICAL ASSISTANCE OR MAINTENANCE ON THE PRODUCT.

In case of replacement of the electric cable, ensure the use of an electric cable certified according to the Standards in force and suitable to the technical features of the product.

Use only flexible cables:

cable type H05RR-FH 3 x 1.5, H05VV-F 3G1.5

Spare parts

Only authorised components can be used for the appliance repairs. Do not repair or replace any oven component not recommended by this manual. All interventions and repairs must be carried out by authorised technical staff.

To request a spare part, indicate the following data:

- 1) Model of oven (**MOD.**) and production number (**N.L.**), found on the product label positioned on the lower front part of the oven and on the first page of the booklet.
- 2) Description and number of the spare part, technical information available only to the authorised assistance service.
- 3) Last, indicate the details of the distributor that sold the oven and the details of your nearest after-sales assistance centre.

Technical assistance

In case your oven requires technical assistance and/or spare parts, contact the dealer or the authorised technical assistance centre nearest to you.

In this case also it is necessary to state all the appliance data on the aluminium product label, such as: model (**MOD**) lot number (**N.L.**), etc, label placed on the lower part of the oven facade or on the first page of the instructions booklet.

ELECTRIC DATA FOR TYPE AND MODEL									
Voltage 220-230-240 V ~ 50/60 Hz									
			FI-60						
Total power	W		3400						
Top element	W		800						
Grill element	W		1800						
Base element	W		1200						
Circular element	W		2200						
Oven light	W		25						
Oven fan	W		30						
Tangential fan	W		20						
Spit	W		-						
EXTERNAL DIMENSIONS									
Width	cm		59,5						
Height	cm		59,5						
Depth	cm		55						
INTERNAL DIMENSIONS									
Gross volume	litres		82						
Grill cooking area	cm ²		1200						

KLEENMAID WARRANTY TERMS AND CONDITIONS

1. Compass Capital Services Pty Ltd ABN 96 138 214 525 trading as Kleenmaid will provide parts and labour to you the customer as set out herein.
2. Kleenmaid's Products come with guarantees that cannot be excluded under the Australian Consumer Law. You are entitled to a replacement or refund for a major failure and for compensation for any other reasonably foreseeable loss or damage. You are also entitled to have the goods repaired or replaced if the goods fail to be of acceptable quality and the failure does not amount to a major failure.
3. The benefits given to you under this Kleenmaid Warranty are in addition to other rights and remedies to which you may be entitled under the Australian Consumer Law in relation to the Product to which this Kleenmaid Warranty relates. Subject to the conditions below, the Product is warranted by Kleenmaid and/or its agents to be free from defects in materials and workmanship for the Warranty Period for normal Domestic Use.
4. Product Identification: -
 - a. Kleenmaid reserves the right to reject claims for any services or work where you cannot produce for verification the serial number and a proof of purchase for the Product (including but not limited to the original invoice).
 - b. This Kleenmaid Warranty will be voided if the serial number for the Product cannot be verified. This is not intended to exclude, restrict or modify any right or remedy to which you may otherwise be entitled under the consumer guarantee provisions of the Australian Consumer Law.
 - c. In the event that a request for repair is made against this Kleenmaid Warranty where the serial number for the Product cannot be verified or you cannot produce for verification a proof of purchase for the Product (including but not limited to the original invoice), the repairer will not carry out any repairs on the Product and you will be charged a service call-out fee.
5. What is covered by this Kleenmaid Warranty: -
 - a. The Product is covered for faulty workmanship or parts that have failed under normal Domestic Use.
 - b. Kleenmaid and/or its agents will determine by objective testing if there are any defects in the Product and/or faulty workmanship.
 - c. This Kleenmaid Warranty is only applicable if repairs on Products are carried out within Mainland Australia.
 - d. This Kleenmaid Warranty: -
 - i. covers a Product purchased as new, manufactured for use in Mainland Australia;
 - ii. commences from the date of delivery of the Product;
 - iii. provides for the labour and replacement parts necessary to maintain the Product in good operating condition as specified in this Kleenmaid Warranty, however, if repair is needed because of Product failure during normal Domestic Use, Kleenmaid has the option to repair or replace the defective Product or part of the Product with a product or part of like kind and quality. A replacement part may be new or reconditioned of like kind and quality and may cost less than the original Product purchased and no charges or refunds will be made based on the replacement product or part cost difference; and
 - iv. is only applicable when the Product is used and operated in accordance with the Manufacturer's instructions.
6. What is not Covered by this Kleenmaid Warranty (excluded):-
 - a. any damage or failure to or of the Product or part of the Product:
 - i. due to the Product being inadequately serviced to manufacturer's recommendations;
 - ii. resulting from environmental conditions including and not limited to dirt, dust, rodents, insects, rust, corrosion, salt built-up, of or in any part of the Product;
 - iii. resulting from excessive use but fair wear and tear is excepted;
 - iv. resulting from poor installation including and not limited to positioning and externally fitted equipment such as plumbing and drainage, cabling, antennae or due to incompatibility of connected equipment;
 - v. caused by overheating as a result of sitting or positioning of the Product, where there is no provision for adequate ventilation or adequate protection from excessive dust;
 - vi. if the Product has been dismantled, repaired or serviced by any person other than someone authorised by Kleenmaid or its agents or representatives;
 - vii. caused by power surges or spikes, including and not limited to, mains power and telecommunications connections, or to other unspecified sources, incorrect power current, voltage fluctuation, amperage fluctuation, rust or corrosion;
 - viii. if the Product is dropped, collision of the Product with another object, use for which the Product is not designed, damage to the Product caused by your own negligence, accidental or deliberate misuse of the Product by you, theft, abuse, vandalism, flood, fire, earthquake, electrical storms or any other act of God or any war related events; or
 - ix. due to the introduction of abnormal heat loads to the Product;
 - b. costs of attendance and testing where no fault or defect covered by the terms of this Kleenmaid Warranty is identified in the Product;
 - c. initial setup and installation of the Product;
 - d. normal maintenance costs and costs incurred through the installation of items listed as requiring periodic replacement;
 - e. Products with removed or altered serial numbers;
 - f. consumables such as but not limited to bulbs/globes, glass, seals, filters, batteries and remote controls;
 - g. removal and reinstallation of an internal component not performed by an authorised Kleenmaid agent or representative or authorised service centre;

- h. cosmetic or structural items; or
 - i. any failures due to interference from or with other products and/or sources.
7. This Kleenmaid Warranty ceases if: -
 - a. the Product ceases to carry the original manufacturer's serial number or is sold at an auction;
 - b. the Product is rented;
 - c. damage to the Product has occurred as listed in point 7a; or
 - d. there is failure to pay monies owing on invoices as a result of non-warranty work been carried out at the request of the end user as per point 16 below.
 8. Neither Kleenmaid nor its representatives provide loan equipment under the terms of this Kleenmaid Warranty.
 9. Any unauthorised access to the internal hardware of the Product will void this Kleenmaid Warranty.
 10. Repair Notice: Products presented for repair may be replaced by refurbished Products of the same type rather than being repaired. Refurbished parts may be used to repair the Products.
 11. Replacement items are "like for like" and is not "new for old" and does not indicate in any way that a faulty Product will be replaced with a new part or unit. "Like for like" may either be a quality checked, refurbished or reconditioned unit of the same or later batch of model/size/specifications
 12. The cost of making a claim under this Kleenmaid Warranty is not covered by Kleenmaid, including any costs of transportation or travel expenses between your home and your nearest authorised service agent.
 13. Kleenmaid accepts no liability for items that are lost, damaged, or stolen as a result of freight, transport or storage. If you are required to transport the Product to an authorised service centre, you must ensure that it is securely packed and insured.
 14. On Public Holidays or other periods when regular business and wholesale operations are temporarily ceased, repairer availability and warranty response times may extend beyond the standard response times due to the unavailability of repairers and parts.
 15. For any repair performed on a Product under this Kleenmaid Warranty where no fault can be found, or the item is deemed by Kleenmaid or an authorised agent, to be not faulty under this Kleenmaid Warranty, or the repair or fault is not covered under this Kleenmaid Warranty, a 'No Fault Found' fee is payable by you. Kleenmaid will advise you of this cost and seek your agreement to pay such costs before commencing such repairs.
 16. Any repairs or services required that are outside the terms and conditions of this Kleenmaid Warranty can be carried out at your request at your cost (including where the Product has not been installed or set up correctly). Kleenmaid will always advise you of this cost and seek your agreement to pay such costs before commencing such repairs. A credit card may be required prior to the commencement of such services.
 17. Extra charges will be payable by the customer should the Product not be readily accessible without special equipment, such as but not limited to cranes and lifts or should the Product be installed in a position that service access is blocked and/or repair work is not possible without uninstalling the Product to gain access.
 18. You, the customer, may be entitled to purchase an extended warranty in respect of the Product. Any extended warranty will not be issued by Kleenmaid but by a third party. Any extended warranty services will be provided directly by the third party as principal and not as agent for Kleenmaid, under their extended warranty terms and conditions and not under this Kleenmaid Warranty.
 19. To make a claim under this Kleenmaid Warranty, please have your proof of purchase and the serial number of the Product ready and call (02) 9310 1207 during business hours.
 20. This Kleenmaid Warranty is given by:
 - Name: Compass Capital Services Pty Ltd ABN 96 138 214 525 trading as Kleenmaid
 - Business address: Level 2, Suite 3, 204 Botany Rd, Alexandria NSW Australia 2015
 - Telephone: (02) 9310 1207
 21. Definitions:
 - a. **Australian Consumer Law** means the *Competition and Consumer Act 2010* (Cth).
 - b. **Domestic Use** means use of the Product for personal, domestic or household purposes.
 - c. **Kleenmaid** means Compass Capital Services Pty Ltd ABN 96 138 214 525 trading as Kleenmaid.
 - d. **Mainland Australia** means the following States and Territories of Australia: New South Wales, Victoria, South Australia, Western Australia, Queensland, Tasmania, Northern Territory, Australian Capital Territory.
 - e. **Product** means the appliance sold by Kleenmaid to you as evidenced by the original purchase invoice.
 - f. **Warranty Period** means the period of 36 months for domestic use, 12 months for non-domestic use or such alternative period as may be specified.

UPDATE NOTICE: This Kleenmaid Warranty is current as at 7 March 2017 but is subject to variation from time to time. For the latest version of the Kleenmaid Warranty, please see our website <http://www.kleenmaid-appliances.com.au/support/your-kleenmaid-warranty> or phone us on (02) 9310 1207.

Other products available in the Kleenmaid range of appliances

- | Washing machines
- | Clothes dryers
- | Dishwashers
- | Ovens
- | Cooktops
- | Steam ovens
- | Microwave ovens
- | Built in espresso
coffee machines
- | Rangehoods
- | Freestanding ovens

Compass Capital Services Pty Limited
trading as Kleenmaid
ABN 96138214525

Level 2, 204 Botany Road
Alexandria NSW 2015

E: support@kleenmaid.com.au
www.kleenmaid.com.au

