

User manual

PITT
BY REGINOX

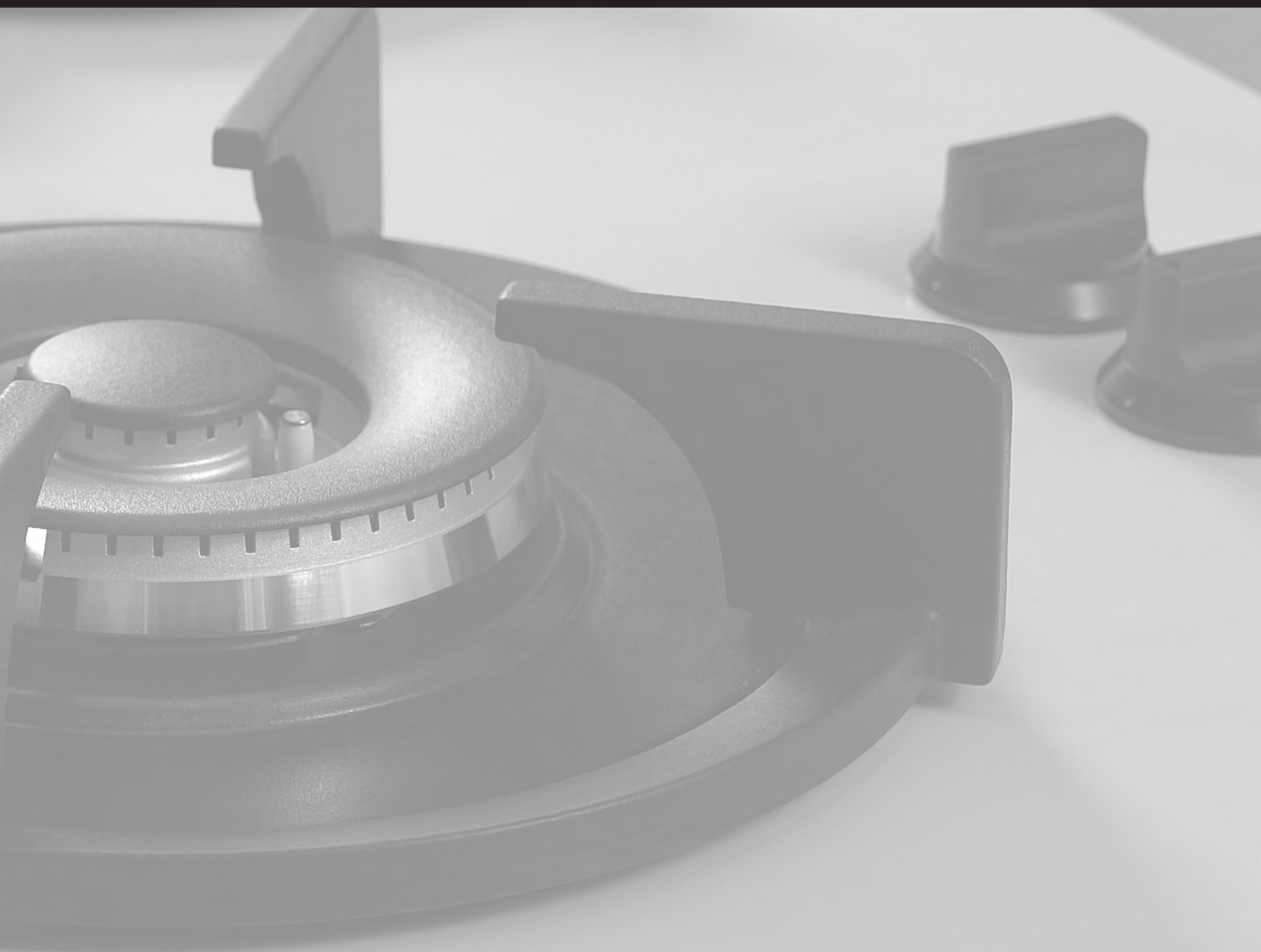

Content

Chapter	Subject	Page
1	Installation dimensions	3
2	Connection: gas and electrical	4
3	General instructions	6
4	Control PITT® by Reginox	7
5	Optimal use of the PITT® by Reginox system	7
6	Maintenance of the PITT® by Reginox system	8
7	Failures in the PITT® by Reginox system	9
8	Models overview	10
9	Packaging	11
10	Service addresses	12

Foreword

Dear customer,

Congratulations on the purchase of your PITT® by Reginox gas hob. This unique system gives you the opportunity to determine the location of each burner which means you are guaranteed to cook with pleasure for many years. Thanks to the various burner capacities you can properly prepare each dish and the integrated spark ignition in the controls ensures that the burners can be handled with one hand. This manual describes how to take full advantage of all the features of this gas hob.

We recommend you read the user manual and mounting instructions carefully before you use the gas hob. The installation and assembly shall be undertaken by an authorised installer.

Do not throw this manual away, so that any following user also benefits from it.

Happy Cooking!

PITT® by Reginox

1 Installation dimensions

Measure in mm

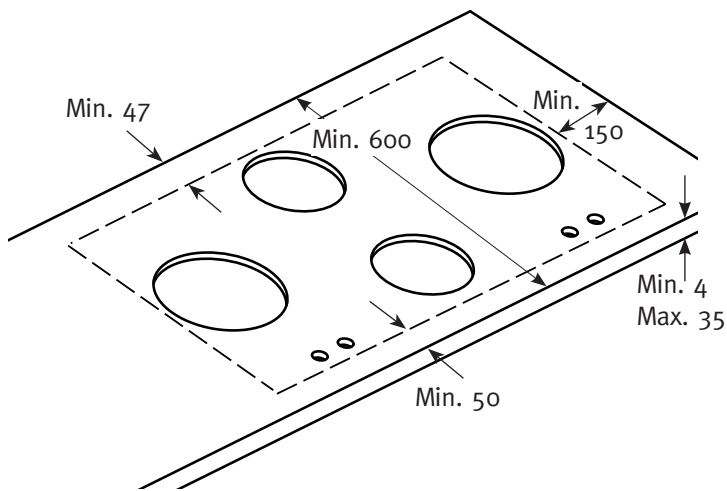

fig. 1

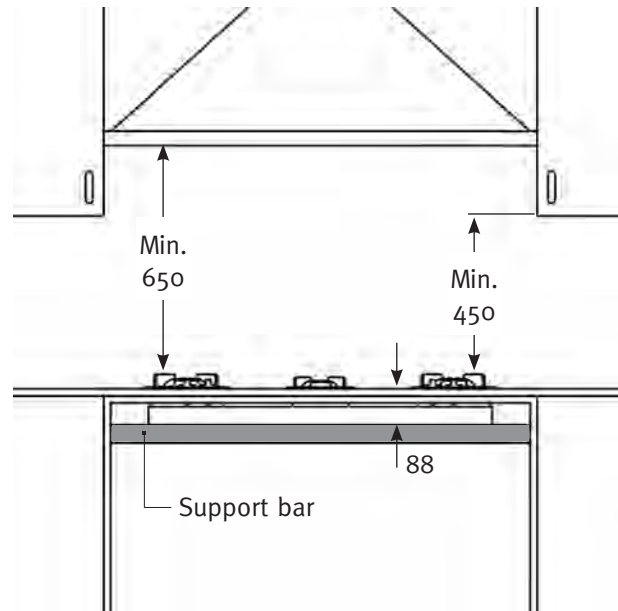

fig. 2

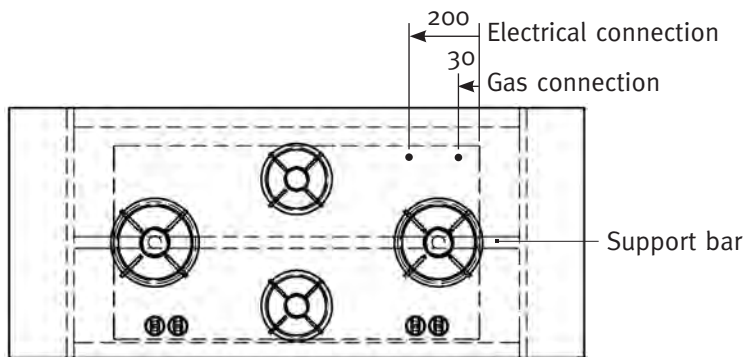

fig. 3

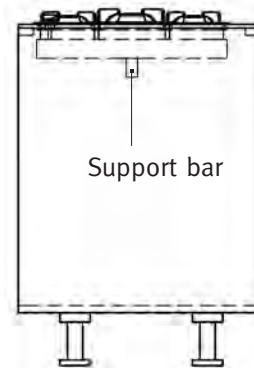

fig. 4

- Adjacent walls, cupboards and protection for combustible materials: Ensure that the appliance is installed in accordance with clauses 6.2.5 and 6.10.1.1 of AS/NZS 5601.1, or clauses 6.9.1 and 6.9.5 of AS/NZS 5601.2 with regard to clearances to combustible surfaces and materials, and clearances to rangehoods and exhaust fans. To ensure clearances of 150mm from burners to vertical combustible surfaces observe the minimum distance requirements shown in Figure 1. Clearances to combustible surfaces may be reduced if combustible surfaces are protected in accordance with clause 6.10.1.2 of AS/NZS 5601.1, or clause 6.9.2 of AS/NZS 5601.2.
- A cooking module cannot be installed over a partition of cabinets. It has to be accessible in case it needs servicing.
- When PITT® by Reginox is combined with a drawer cabinet, always be aware of the measurements of the unit. The height of the unit is 88 mm.
- If your countertop has a panel thickness less than 20mm and your cabinet size is 900 mm or bigger the module needs to be fully supported inside the cabinet (fig 2,3 and 4).

MATERIALS USED FOR INSTALLATION MUST BE HEAT RESISTANCE AND BE RESISTANT TO HIGH TEMPERATURES. THE FOLLOWING WORKTOP MATERIALS ARE ALLOWED TO USE IN COMBINATION WITH PITT® BY REGINOX:

- Quartz stone
- Natural stone
- Glass
- Concrete
- Solid Surface
- Compact panel
- Ceramics
- Terrazzo
- Stainless steel

2 Connection: gas and electrical

Gas connection instructions

- Check that installation or local distribution regulations (type of gas and gas pressure) match the setting value of this device.
- The setting values of this device are indicated on the data plate.
- Installation and connection must comply with the regulations in force locally and nationwide. You must check the regulations in regards to ventilation requirements.
- The gas connection must comply with the general regulations. We recommend to connect the hob with a fixed gas pipeline or to use an approved gas hose.
- Install the pressure regulator (fig 4a) (supplied with unit) to manifold pipe using pipe-joint compound (resistant to LPG and Natural gas) on threads of manifold pipe. Turn to hand tighten plus 1/4 turn, not exceeding 1 turn for alignment. To prevent possible damage to the gas pressure regulator, install it after the appliance is in its permanent position. When the regulator is securely installed on the manifold pipe, the conversion nut will be easily accessible.
- See manual Maxitrol converting NG to LPG enclosed by regulator.
- When connecting appliance using a flexible hose assembly, use a hose complying with AS/NZS1869 - Class B or D and be no longer than 1.2m long. The hose should not come in contact with any hot surface e.g. dishwasher or under bench oven. The isolating valve to be accessible when the appliance is installed
- An approved gas hose should not be kinked and should not come into contact with moving parts of the kitchen furniture.
- The main gas supply must be in an easily accessible place.
- Before using the cooking unit check all the connections for leaks with a soap solution.

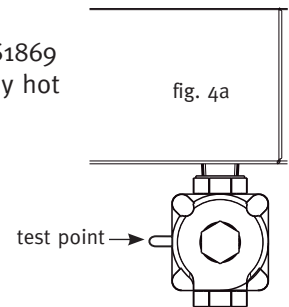

Checking the gas supply for natural gas

- Check the manometer zero point is correct.
- Connect the manometer to the cooktop test point. This is located on the regulator.
- Turn on the gas supply and electricity and try to ignite the gas.
NOTE! It will take additional time to light the gas for the first time as air needs to be purged from the pipes.
- With the appliance operating check the outlet pressure
 - when all burners of the appliance are operating at maximum,
 - when the smallest burner of the appliance is operating at minimum.
- Adjust the pressure if the the outlet pressure vary more than 0.20kPa. of the nominal outlet pressure of 1.00kPa.

Electrical connection instructions*

230 V – 50 Hz – 0,6 VA

- The electrical installation must conform to the national and local regulations.
- Power socket and plug must always be reachable.
- Connect the unit with the supplied plug to an earthed socket.
- Damage to the connection cable may only be replaced by the manufacturer, or an approved Installer. This to prevent dangerous situations.

Battery spark ignition*

1,5V DC

- The spark ignition operates through a battery AA.
- The battery is positioned in the casing at the underside.
- Replace the battery if the spark ignition does not operate

* Depending on the model

Models PITT® by Reginox overview

Model PITT	MJ/h	Model PITT	MJ/h
Abeki	7,2	Capital (XL)	36
Akan	7,2	Cima (XL)	36
Adams	10,8	Cusin	46,8
Altar	10,8	Dempo (XL)	54
Air	18	Danau	54
Azuma	18	Drum	54
Balut	18	Ebeko (XL)	54
Bandal	18	Elbrus (XL)	54
Baluran	28,8	Enep (XL)	54
Bennett	25,2	Foessa (XL)	72
Baula	28,8		
Bely	25,2		

Gastype - nozzle combination overview

Gas	Supply pressure	Burner R 7,2 MJ/h nozzle	Burner SR 10,8 MJ/h nozzle	Burner Dual 18 MJ/h outer ring nozzle	Burner Dual 18 MJ/h inner ring nozzle
	kPa	mm	mm	mm	mm
NG	1.0	1.16	1.50	2x 1.30	1x 0.80
Universal LPG	2.75	0.73	0.94	2x 0.78	1x 0.50

Unit category

Gas	NG	LPG		
Supply pressure	1.0 kPa	2.75 kPa		

3 General instructions

SAFETY WARNINGS



Read the instructions in this user manual carefully. Only then you can use your PITT® by Reginox gas hob the right way.

Save both the Assembly instructions and the user manual. If the PITT® by Reginox system transfers to another user, they need this documentation.

Check the PITT® by Reginox system immediately after removing the packaging. If there is any shipping damage you should contact PITT® by Reginox immediately by e-mail or in writing.

DO NOT MODIFY THIS APPLIANCE

Safety Rules

1. PITT® by Reginox is intended for domestic use only.
 2. Only use the gas hob for the preparation of dishes. Don't use it as space heater in a home, caravan or marine craft.
 3. Please ensure that all burner parts are placed correctly.
 4. Ensure adequate ventilation during use.
 5. Distance from the pan to a non-heat resistant wall or control knob must be at least 2 cm or 0,8 inches.
 6. Always place pans on the pan support, never directly on the burner top.
 7. Check the product regularly for damage. Do not use the product when damaged, repair it immediately.
 8. The user is responsible for the proper use and good state of the system.
When used incorrectly, the manufacturer is not liable for any damages.
-  **OVERHEATING AND FIRE HAZARDS**
9. Use the burner only with a pan or a wok on the pan support. Warning: an empty pan may overheat.
 10. Overheated oil or butter can easily ignite. Never put out with water. You can smother the flames by closing the pan with a lid.
 11. **DO NOT** flambé under a cooker hood, this can cause a fire.
 12. **DO NOT** use or store flammable materials in the appliance while it is in operation.
 13. **DO NOT** spray aerosols in the vicinity of this appliance while it is in operation
 14. Never place a grill or griddle over two burners.
 15. **DO NOT** use pans with a larger base diameter than the pan support. We recommend for the 2 and 3KW burners a pan with a maximum base diameter of 230 mm and for the 5KW burner a maximum base of 270 mm.
-  **HOT PARTS**
16. Parts of the burner and the worktop surrounding the burner may become hot during use and will remain hot for a long period after use. Please take care not to touch these parts until they have fully cooled.
 17. Please be aware that if you use a pan with a larger base diameter than the pan support (see point 14) there is a possibility that the control knobs may become hot.
 18. Please be aware that the flame should always remain beneath the base of the pan (unless you are stir frying with a wok). Flames rising against the side of the pan will not be effective and will produce unwanted overheating.
 19. It is very important that children remain at a distance.

4 Control PITT® by Reginox

Burners PITT® by Reginox



1,1 - 7,2 MJ



1,1 - 10,8 MJ



0,7 - 18 MJ

Burners ignite and set

Before you ignite the burner verify that all components are mounted in the right way to prevent unwanted interference. Before igniting the burner you need to place a pan on the hob. Each burner can be set easily between high and low.

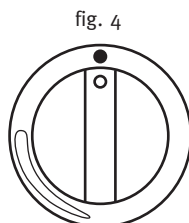

fig. 4
Burner off

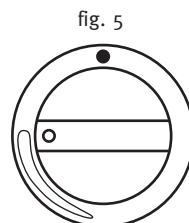

fig. 5
High flame size

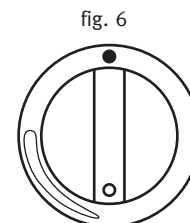

fig. 6
Low flame size

IGNITING

To ignite the burner you need to activate the spark ignition. You do this by pressing the control knob all the way and hold. Turn the control knob to the left (Figure 5). Keep the button pressed for another 5 to 8 seconds. This way the temperature sensor warms and gas can be distributed. You can regulate the size of the flame by turning the control knob slowly between the high and low position (Figure 5 and 6).

CAUTION: If the flame does not ignite after 2 to 4 seconds, you need to return the knob to the low position (Figure 6). A small flame often kindles faster than a large flame.

TURNING OFF

To turn off the burner, turn the control knob back to the state displayed on Figure 4.

5 Optimal use of the PITT® by Reginox system

- Avoid flames rising around the pan to minimise the loss of energy. Be careful as the handles of the pans can become hot.
- To cook large quantities you best use the stir-fry cooker. For preparation of sauces and simmering dishes best use the side burner. To cook through it should be on the highest level.
- Cooking with the lid on the pan conserves energy.
- Use cookware with a flat, clean and dry bottom. Flat pans are more stable and a clean bottom makes for a better heat transfer.

Wok burner

With the cooker you can prepare dishes at a very high temperature. It is important, however, to pay attention to a number of things:

- Make sure you have the ingredients cut in advance.
- Use an oil of good quality for frying, for example: olive oil, sunflower oil or peanut oil. Do not use butter or margarine as these will be overheated and blackened by high temperatures.
- To ensure all the ingredients are ready at the same time, you must put the ingredients with the longest preparation time in the pan first.

6 Maintenance of the PITT® by Reginox system

PITT® by Reginox is manufactured with high-grade materials, which can be very easily cleaned.

Please take the following into consideration:

1. Never clean in the dishwasher as the detergent can affect the materials. Avoid cleaning with too much moisture as the can enter the burner outlet and cause damage.
2. Use a cloth to clean the electric spark ignition (fig. 7). In case of heavy use it can be cleaned with the point of a fine brush. Do this carefully as an accidental change in the distance between the burner and spark ignition may result in the burner being damaged or failing to ignite.
3. Place the pan support directly onto the burners without scratching your countertop.
4. Assemble the burner parts via the centring cams in each part (see fig. 8).
5. Clean the cooker immediately after use. This prevents overcooked food settling on the burner and becoming difficult to remove.
6. Start with cleaning the buttons, burners and pan support. Then clean the countertop to prevent it from being stained again.
7. Use a mild detergent and a soft cloth to clean the removable burner parts. Stubborn stains on pan carriers and burner tops are best removed with a liquid cleanser.
8. Never use scouring powders, pads, sharp objects or aggressive cleaning agents.
9. For maintenance and cleaning of the countertop refer to the manual of the particular product.

CAUTION: The PITT® by Reginox system must not be steam cleaned or high-pressure cleaned. If cleaned this way the electrical safety is not ensured.

fig. 7



Electric spark ignition

fig. 8

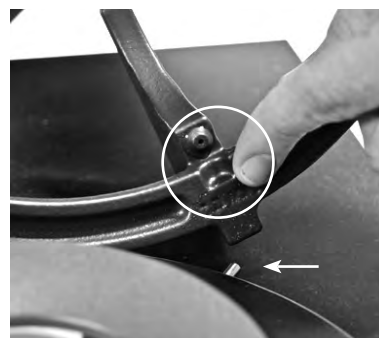

Pan support with centering cams

7 Failures in the PITT® by Reginox system

CAUTION: the PITT® by Reginox-system may only be connected by an approved installer. To ensure the safety and warranty repairs may only be performed by approved professionals. You should only use original parts.

Failure	Cause	Solution	Chapter / Page
A burner ignites and turns off again.	The control knob is not pressed long enough to activate the auto-flame detection.	Press the control knob down long enough to turn between full and low heat.	Chapter 4 / page 7
	The control knob is not adjusted at the correct height.	Adjust the control knob properly.	Installation manual step 17 t/m 22.
The control-button touches the sealing scale.	Hob is not mounted the right way under the countertop.	Adjust the control knob properly.	Installation manual step 17 t/m 22.
	Sealing scale is not in the center vs. control knob.	Detach sealing scale and and re-stick again.	Installation manual step 25 t/m 26.
Spark ignition remains igniting.	Hob is not mounted the right way under the countertop.	Adjust the control knob properly.	Installation manual step 17 t/m 22.
	Sealing scale is not in the center vs. control knob.	Detach sealing scale and and re-stick again.	Installation manual step 25 t/m 26.
The burner doesn't ignite.	The control knob is not adjusted at the correct height.	Adjust the control knob properly.	Installation manual step 17 t/m 22.
	The power plug is not in the power socket.	Put the power plug into the power socket.	Installation manual step 13.
	Fuse malfunction / fuse in meter cupboard is disabled.	Install a new fuse or switch on the fuse again.	
	Spark ignition is dirty or wet.	Clean or dry the spark ignition.	Chapter 6 / page 8
	Burner parts are not properly mounted.	Ensure the burner parts are correctly aligned with the centring cams.	Chapter 6 / page 8
	Burner parts are dirty or wet.	Clean or dry the burner parts. Make sure the outflow holes are open.	Chapter 6 / page 8
	The main gas supply is not open.	Open the main gas supply.	
	The control knob is not pressed long enough	Press the control knob down long enough to turn between full and low heat.	Chapter 4 / page 7
	Battery empty*	Replace battery	Chapter 2 / page 4
A burner does not burn evenly.	Burner parts are not placed properly.	Ensure the burner parts are correctly aligned with the centring cams.	Chapter 6 / page 8
	Burner parts are dirty or wet.	Clean or dry the burner parts. Make sure the outflow holes are open.	Chapter 6 / page 8
Gas smell.	Gas connection leaks.	Check the connection. Turn main gas supply off immediately when you're not able to fix it right away.	
	There is a burner turned on, but not inflamed.	Close the control knob and wait a few minutes before reigniting.	Chapter 4 / page 7

If the failure still remains please contact your dealer or the PITT® by Reginox customer service: See the service addresses on page 12.

8 Models overview

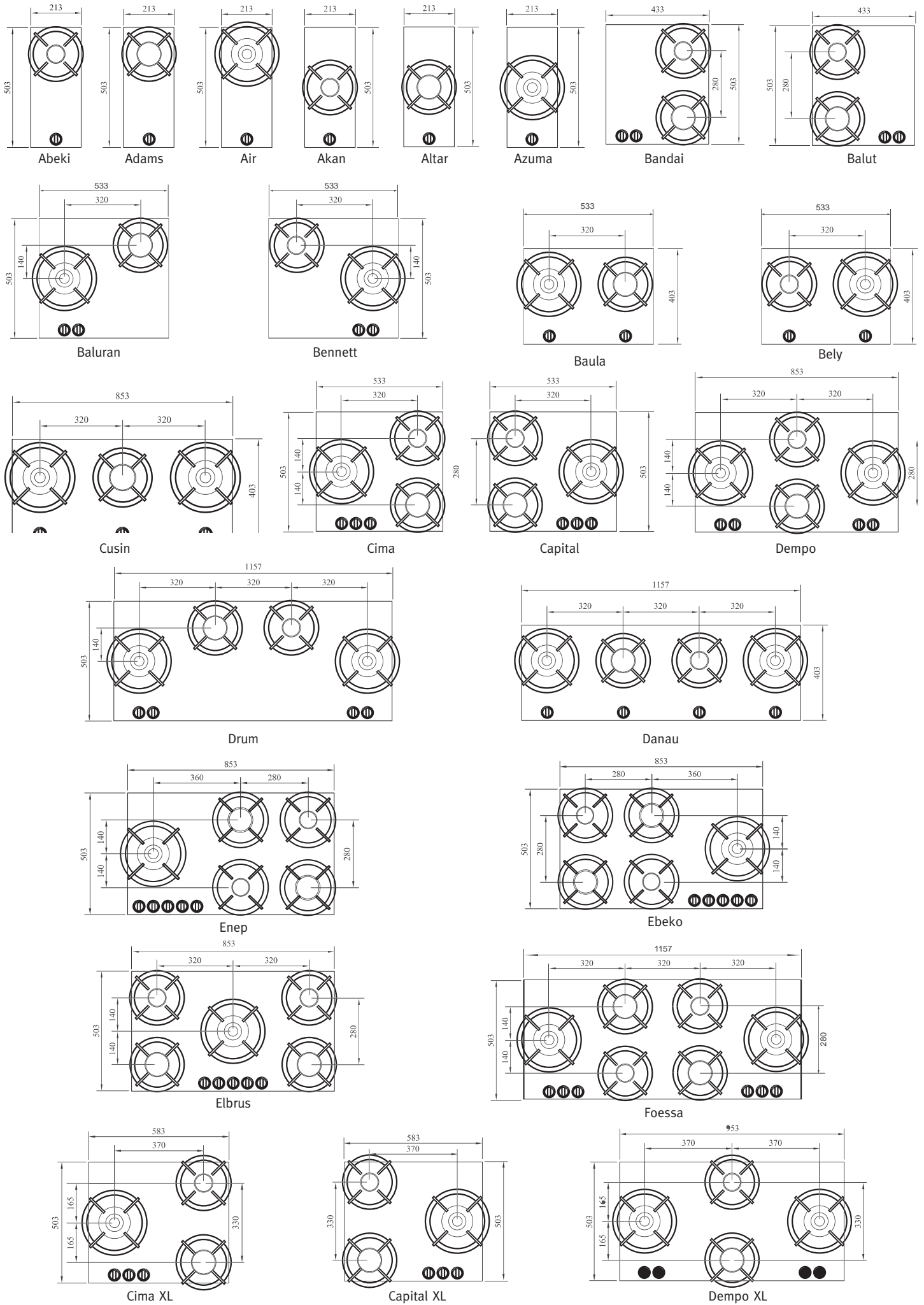

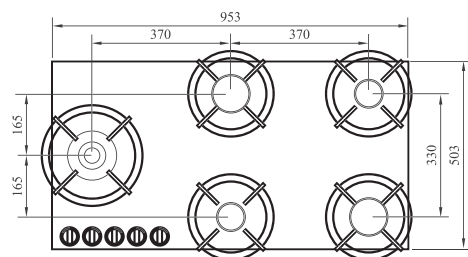

Enep XL

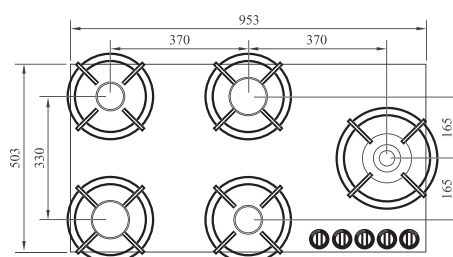

Ebeko XL

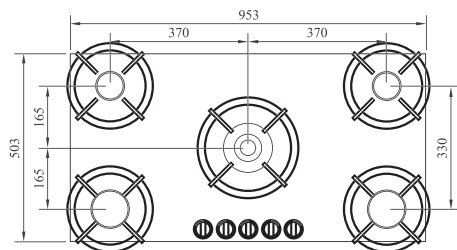

Elbrus XL

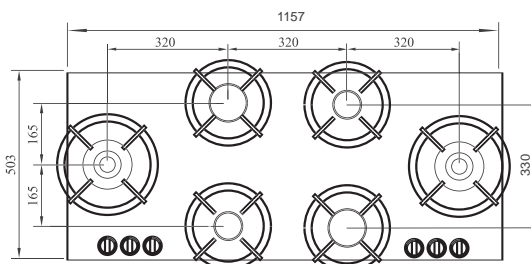

Foessa XL

9 Packaging

The PITT® by Reginox system is manufactured using sustainable materials. The packaging is recyclable and consists of the following types of materials:

- paperboard
- paper

These materials are in accordance with the provisions of Government to be disposed of in a responsible manner. The packaging of this product is equipped with a sticker with the image of a crossed-out dustbin (see Figure 9).

afb. 9



The directive on waste electrical and electronic equipment (WEEE) of the European Union. The WEEE directive of the European Union requires that products that are sold in the countries of the EU (or in some cases the packaging thereof) must be labelled with a crossed-out dustbin. As determined by the WEEE directive, this means label with the crossed-out dustbin that customers and end users in the countries of the EU electrical and electronic equipment or accessories not with the garbage may dispose. Customers and end users within the EU should contact their local supplier or maintenance centre for information about the waste collection system in their municipality.

Made in Holland
